



Semplice installazione, lunga durata, sistema di dissipazione termica studiato internamente e resistenza ad elevate temperature fanno di PROXIMO la serie di armature stradali con il miglior rapporto qualità prezzo oggi disponibile sul mercato. Disponibile in tre taglie differenti, l'obiettivo della serie PROXIMO è quella di garantire una maggior sicurezza soddisfacendo le diverse esigenze illuminotecniche in ambito stradale, urbano ed extraurbano e diversi livelli di intensità di traffico, fino a contesti di aree residenziali, parchi, piazze ed agglomerati urbani. La gamma PROXIMO, prodotta in base ai dettami dell'economia circolare, rappresenta il nuovo punto di riferimento nell'ambito dell'illuminazione stradale con soluzioni flessibili WISE e prospettiche, per futuri scenari smart.

Simple installation, long life, internally designed heat dissipation system and resistance to high temperatures make PROXIMO the series with the best value for money available today on the market.

Available in three different sizes, the mission of the PROXIMO series is to guarantee greater safety, satisfying the different lighting needs in the street, urban and extra-urban and different traffic intensity, up to contexts of residential areas, parks, squares and urban agglomerations.

The PROXIMO range, manufactured according to the dictates of the circular economy, represents the new benchmark in the field of lighting road with flexible and prospective WISE solutions for future smart applications.



MATERIALI E FINITURE



- Base portante e copertura in pressofusione di alluminio con titolo minimo EN 47100 a basso contenuto di rame ed alta resistenza agli agenti atmosferici.
- Copertura superiore con alette di raffreddamento trasversali ad alto contenuto estetico.
- Verniciato con il processo AION, a polveri poliestere di colore Silver (RAL 9006) resistente ai raggi UV secondo la norma ASTM D4587:2011 e alla nebbia salina secondo la norma EN ISO 9227:2017, con durata minima all'esposizione di 3000 ore.
- Coperchio posteriore per la chiusura del vano attacco palo in materiale plastico ad alta resistenza (solo per PROXIMO).
- Filtro di compensazione pressoria in teflon.
- Guarnizioni in gomma antinvecchiamento, rimovibili.
- Schermo di protezione in vetro di sicurezza temperato extra chiaro 4 mm.
- Viteria esterna imperdibile in acciaio INOX.
- Molla di chiusura in acciaio INOX.

CARATTERISTICHE MECCANICHE

- Sostituzione dell'intero modulo LED completo della copertura dell'apparecchio.
- Apertura per l'accesso all'ottica e vano cablaggio in un'unica e semplice operazione agendo sulla molla in acciaio inox senza l'utilizzo di utensili.
- Per evitare la chiusura accidentale della copertura durante le fasi di montaggio e manutenzione, l'apparecchio è dotato di dispositivo automatico di blocco.

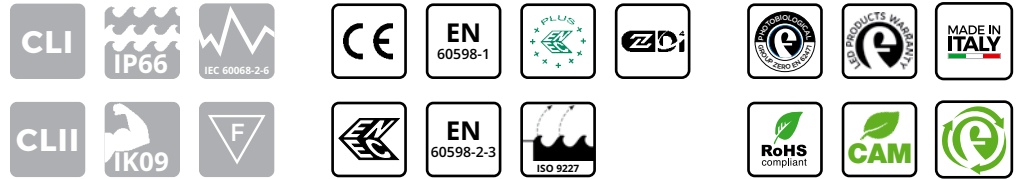

MATERIALS AND FINISHES



- Body and cover in die-cast aluminum with minimum EN 47100 title with low content copper and high resistance to atmospheric agents.
- Upper cover with cross-sectional cooling fins with highly aesthetic aspect.
- Coated with the AION process, in silver-colored polyester powders (RAL 9006) resistant to UV rays according to ASTM D4587:2011 standard and to salt spray according to EN ISO 9227:2017, with a duration of 3000 hours.
- Rear cover for closing the attachment compartment pole in high resistance plastic material (only for PROXIMO).
- Pressure compensation filter in Teflon.
- Gaskets in anti-aging rubber, removable.
- Extra-clear tempered safety glass protection screen, 4mm thick.
- Stainless steel external captive screws.
- Stainless steel closure clip.

MECHANICAL CHARACTERISTICS

- Replacement of the entire LED module including the upper cover.
- Opening provides access to optics and cable box in a single, easy step by using the quick release clip in stainless steel, without using additional tools.
- To prevent accidental closure of the cover during assembly and maintenance, the device is equipped with an automatic anti-closing mechanism.

INSTALLAZIONE / INSTALLATION



Installazione a palo con sistema di attacco regolabile in alluminio pressofuso.
Adjust pole mounting system in die cast aluminium.

	PROXIMO	PROXIMO CITY	PROXIMO WAY
Diametro palo Pole diameter	Ø 46 mm ÷ 76 mm	Ø 46 mm ÷ 76 mm	Ø 46 mm ÷ 60 mm
Installazione a testa palo Installation on straight pole	0°, +5°, +10°, +15°, +20°	da 0° a +20° con passo costante di 2,5° from 0° to +20° with constant pitch of 2.5°	
Installazione a sbraccio Side entry installation	Dispositivo di fissaggio a palo per portare a 0° il tilt dell'apparecchio in caso di installazione su bracci con tilt di 5°, 10°, 15° e 20°. Fixing device pole to bring the tilt luminaire at 0° in case of side entry installation with tilt of 5°, 10°, 15° and 20°		
Altezza di installazione Installation height	4 ÷ 30 m	4 ÷ 20 m	4 ÷ 16 m

DIMENSIONI / DIMENSIONS

PROXIMO

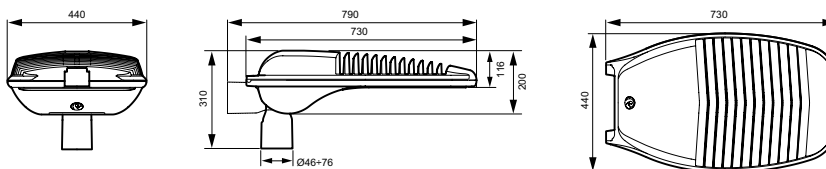

Peso max*
Max weight*

14,30 kg

Sup. esposta al vento con tilt 0°
Wind exposed surface with tilt 0°

laterale / lateral: 0,094 m²
frontale / front: 0,083 m²

PROXIMO CITY

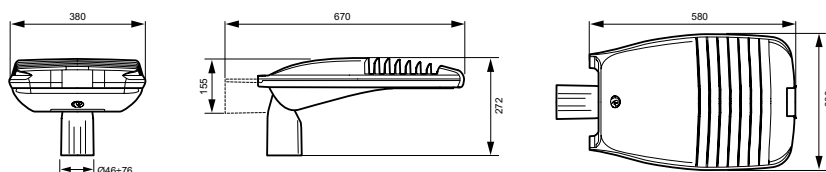

Peso max*
Max weight*

9,30 kg

Sup. esposta al vento con tilt 0°
Wind exposed surface with tilt 0°

laterale / lateral: 0,064 m²
frontale / front: 0,061 m²

PROXIMO WAY

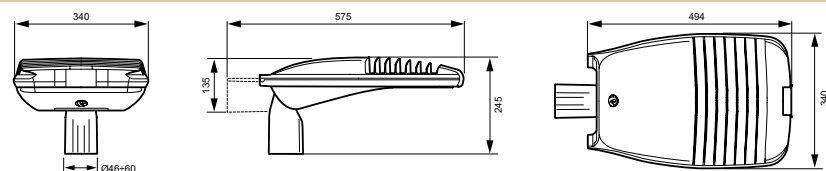

Peso max*
Max weight*

6 kg

Sup. esposta al vento con tilt 0°
Wind exposed surface with tilt 0°

laterale / lateral: 0,039 m²
frontale / front: 0,041 m²

* Tolleranza sul peso ± 5%
* Weight tolerance ± 5%

PROTEZIONE ALLE SOVRATENSIONI

- CL I: fino a 10kV sia di modo comune che differenziale.
- CL II: fino a 10kV di modo comune, 6kV di modo differenziale. A richiesta è possibile raggiungere 10kV anche in modo differenziale con SPD collegato tra fase e neutro.

CARATTERISTICHE DI ALIMENTAZIONE

- Gruppo di alimentazione costituito da driver programmabile con durata di vita maggiore di 100.000h.
- Alimentatore elettronico con protezione termica integrata ad elevata efficienza e durata progettato per uso esterno. Tutte le versioni sono protette contro le sovratensioni e le sovracorrenti per la protezione dei componenti e dei LED.
- Il sistema, sia in CL I che in CL II, è dotato di sezionatore per interrompere l'alimentazione all'apertura dell'apparecchio.
- Ingresso cavo attraverso pressacavo PG16 antistrappo, IP68.
- Fattore di correzione di potenza a pieno carico > 0.9.
- Alimentazione 220 - 240V / 50 - 60 Hz VAC.
- Piastra cablaggio completa di unità elettronica facilmente sostituibile.



WISE SOLUTIONS (OPTIONAL)

- Dimmerazione automatica tramite sistema di mezzanotte virtuale con profili programmati che soddisfano le richieste del cliente.
- Funzionalità CLO: programmazione dell'alimentazione in modo tale da aumentare gradualmente la corrente di pilotaggio dei led e compensarne il decadimento fisiologico.
- Orologio astronomico: funzionalità che permette l'accensione e lo spegnimento dell'impianto in funzione di determinate fasce orarie preimpostate.
- 1-10V: interfaccia di dimmerazione analogica mediante protocollo 1-10V.
- DALI: interfaccia di dimmerazione digitale mediante protocollo DALI.
- Regolazione del flusso luminoso tramite onde convogliate.
- Main voltage dimming: funzionalità che permette la variazione del flusso luminoso agendo sulla variazione della tensione di alimentazione fornita dal quadro di comando dell'impianto di illuminazione.
- NEMA: Presa 7 pin (ANSI C136.41).
- ZHAGA: Presa 4 pin (ZHAGA Book 18). Prodotto certificato Zhaga-D4i.

PROTECTION AGAINST SURGES

- CL I: up to 10kV both common and differential mode.
- CL II: up to 10 kV common mode, differential mode 6kV. On request it is possible to reach 10kV also in differential mode with SPD connected between phase and neutral.

POWER SUPPLY CHARACTERISTICS

- Power supply unit consisting of a programmable driver with a lifespan greater than 100,000h.
- Electronic power supply with integrated thermal protection with high efficiency and durability intended for external use. All versions are protected against overloads and surges to protect components and LEDs.
- The system, both in CL I and in CL II, is equipped with a knife switch to interrupt the power supply at the device's opening.
- The power supply cable accesses the device through a PG 16 cable gland (IP68).
- Power correction factor at full load > 0.9.
- Power supply 220 - 240V / 50 - 60 Hz VAC.
- Cable plate complete with easily replaceable electronic unit.



WISE SOLUTIONS (OPTIONAL)

- Automatic dimming through virtual midnight system with customized profiles according to specific needs.
- CLO functionality: the driver can be programmed to gradually increase the level of drive current fed to the LEDs in order to compensate their physiological lifespan reduction.
- Astronomical clock: this function the system to be switched on and off according to certain preset time slots.
- DALI: digital dimming interface via DALI protocol.
- 1-10V: analog dimming interface via 1-10V protocol.
- Adjustment of the luminous flux through conveyed waves.
- Main voltage dimming: this function allows the variation of the luminous flux by acting on the variation of the power supply voltage supplied by the control panel of the lighting system.
- NEMA SOCKET: 7 pins (ANSI C136.41).
- ZHAGA SOCKET: 4 pins (ZHAGA Book 18). Zhaga-D4i certified product.

- Sistema ottico stradale **SAFEWAY®** a rifrazione/riflessione e a rifrazione.
- Gruppo ottico facilmente sostituibile.
- Tecnologia LED Multi-die, Singlechip e Multichip su circuito stampato in alluminio altamente dissipante termicamente MCPCB (Metal Core Printed Circuit Board).
- Sistema di dissipazione del calore mediante alette di raffreddamento trasversali.
- Temperatura colore sorgente LED: 4000K - CRI > 70. Gli apparecchi sono disponibili, su richiesta, anche con temperatura di colore compresa tra 2700 e 5700K.

CARATTERISTICHE SISTEMA OTTICO

OPTICAL SYSTEM CHARACTERISTICS

- **SAFEWAY®** optic system: refraction / reflection system and refraction system.
- Optic group easily replaceable.
- Multi-die, Singlechip e Multichip LED Technology on a pressed aluminum circuit, highly dissipating MCPCB (Metal Core Printed Circuit Board).
- Thermal dissipation system by means of cross-sectional cooling fins.
- Color temperature: 4000K - CRI>70. The streetlights are available on request also with color temperatures between 2700 and 5700K.

SISTEMA OTTICO A RIFRAZIONE/RIFLESSIONE

REFRACTION/REFLECTION OPTIC SYSTEM



SISTEMA OTTICO A RIFRAZIONE

REFRACTION OPTIC SYSTEM



FLUSSO LUMINOSO MEDIO MANTENUTO SECONDO LA NORMA LM80 - TM21

MAINTAINED AVERAGE LUMINOUS FLUX ACCORDING TO LM80 - TM21 STANDARDS



Intervallo di temperatura di esercizio delle armature stradali*
Streetlights operating temperature range*

Ta 35°C -40°C ÷ +40°C L90B10 >100.000 hrs

Ta 55°C -40°C ÷ +55°C L80B10 >50.000 hrs

*Temperatura massima di esercizio dell'apparecchio in condizioni normali. Questa indicazione non esclude un funzionamento temporaneo dell'apparecchio alle temperature di esercizio indicate.

*Maximum operating temperature of the floodlights in normal conditions. This indication does not exclude temporary operation of the floodlights at the indicated operating temperatures.



Curve fotometriche / Photometric data

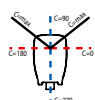
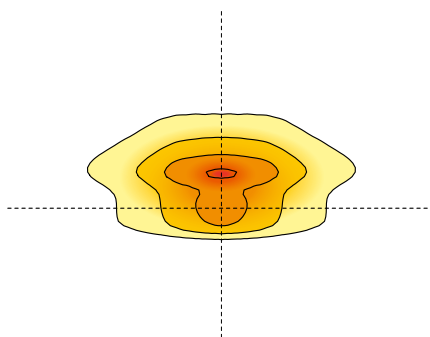
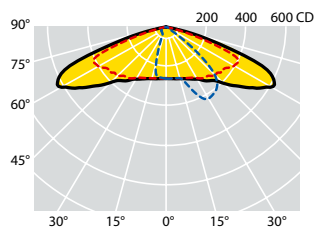

C max = 20°
LED 2mmq

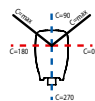
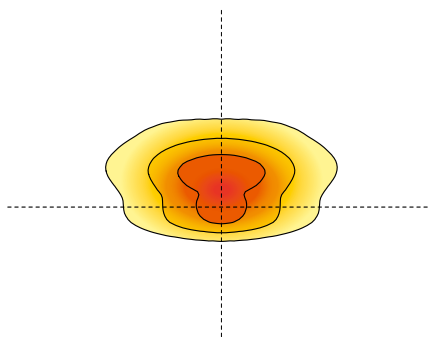
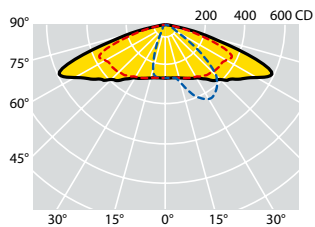

C max = 15°
LED 4x4mmq

OTTICA AB1:

Ottica stradale normalmente impiegata per tutte le categorie illuminotecniche, specialmente quando il rapporto tra l'altezza di installazione dell'apparecchio e la larghezza della carreggiata è maggiore di 0,85. Risolve strade con rapporto tra l'interdistanza dei pali e l'altezza di installazione anche superiore a 4.

AB1 OPTIC:

Street optic normally used for all street illumination categories, especially when the relation between the installation height and the carriage width is greater than 0.85. This optic solves roads with a relationship between the poles distance and the installation height even higher than 4.

Codici prodotto / *Product codes*

4000K - CRI > 70

Codice Code CL I	Codice Code CL II	Numero LED Number of LED	Ottica Optic	Corrente di pilotaggio Led Current (mA)	W (LED+ DRIVER)	Flusso lum. nom. piastra LED Nominal flux LED plate (Lumen)	Flusso utile in uscita Useful output flux (Lumen)	Temp. ambiente Ambient temp. ta 35°C ta 55°C		Peso lordo Gross weight (kg)	Vol. (m ³)
44501	44701	49 LED	AB1	530mA	81	14450	12080	•	•	16,60	0,0772
44502	44702	49 LED	AB1	700mA	106	17850	14900	•	•	16,60	0,0772
44503	44703	56 LED	AB1	530mA	90	16100	13450	•	•	16,60	0,0772
44504	44704	56 LED	AB1	700mA	120	19900	16610	•	•	16,60	0,0772
44505	44705	63 LED	AB1	530mA	105	18050	15070	•	•	16,60	0,0772
44506	44706	63 LED	AB1	700mA	135	22300	18600	•	•	16,60	0,0772
44507	44707	70 LED	AB1	530mA	117	19900	16600	•	•	16,60	0,0772
44508	44708	70 LED	AB1	700mA	148	24050	20080	•	•	16,60	0,0772
44509	44709	77 LED	AB1	530mA	125	21500	17930	•	•	16,60	0,0772
44510	44710	77 LED	AB1	700mA	166	26750	22330	•	•	16,60	0,0772
44517	44717	84 LED	AB1	530mA	135	23350	19470	•	•	16,60	0,0772
44518	44718	84 LED	AB1	700mA	182	29100	24260	•	•	16,60	0,0772

Tecnologia LED Singlechip (2mmq)

Singlechip LED technology (2mmq)

57001	57110	20 LED	AB1	700mA	168	29100	24270	•	•	16,80	0,0772
44574	44575	20 LED	AB1	800mA	192	33100	27590	•	•	16,80	0,0772
57002	57111	20 LED	AB1	900mA	216	35200	29370	•	•	16,80	0,0772
44576	44577	20 LED	AB1	1000mA	240	38900	32430	•	•	16,80	0,0772
44578	44579	24 LED	AB1	800mA	230	38900	32430	•	•	16,80	0,0772
57003	57112	24 LED	AB1	900mA	259	41350	34470	•	•	16,80	0,0772
44580	44581	24 LED	AB1	1000mA	288	45800	38180	•	•	16,80	0,0772
44589	44590	28 LED	AB1	700mA	235	39150	32640	•	•	17,20	0,0772
44582	44583	28 LED	AB1	800mA	268	44500	37120	•	•	17,20	0,0772
57004	57113	28 LED	AB1	900mA	301	48050	40080	•	•	17,20	0,0772
44584	44585	28 LED	AB1	1000mA	335	53300	44420	•	•	17,20	0,0772

Tecnologia LED Multichip (4X4mmq)

Multichip LED technology (4X4mmq)

I valori di flusso indicati devono essere considerati con una tolleranza del +/- 10%.
I valori di potenza elettrica indicati devono essere considerati con una tolleranza del +/- 7%.
I flussi luminosi indicati in tabella subiranno modifiche e miglioramenti in funzione della continua evoluzione tecnica dell'efficienza luminosa dei led.

*The flux values are to be considered with a tolerance of +/- 10%.
The wattages values are to be considered with a tolerance of +/- 7%.
The flows indicated in the table may be changed and improved according to the constant technical evolution of the light efficiency of the led.*



Curve fotometriche / Photometric data

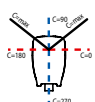
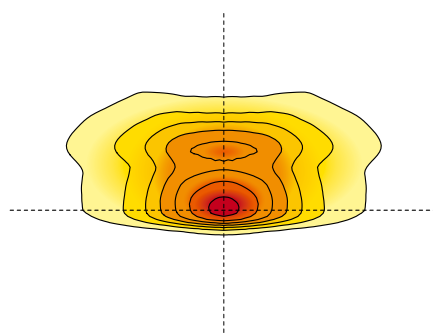
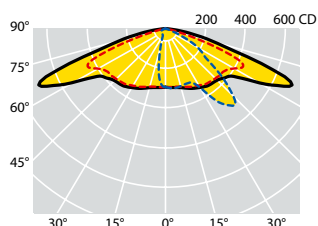

C max = 30°
LED 2mmq

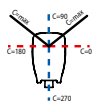
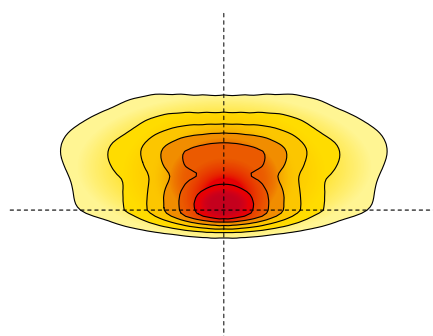
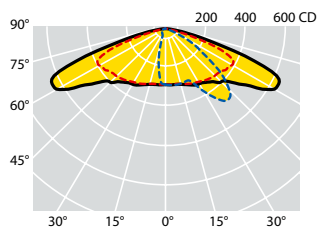

C max = 25°
LED 4x4mmq

OTTICA L10:

Ottica stradale normalmente impiegata per tutte le categorie illuminotecniche, specialmente quando il rapporto tra l'altezza di installazione dell'apparecchio e la larghezza della carreggiata è notevolmente maggiore di 1. Grazie al sistema ottico brevettato Safeway, che sfrutta la possibilità di inclinare i riflettori con angoli diversi, tale ottica permette di illuminare aree frontali molto ampie, risolvendo larghe carreggiate, strade a più corsie, parcheggi e piazzali molto profondi.

L10 OPTIC:

Street optic normally used for all categories lighting, especially when the installation height and the carriage width ratio is considerably greater than 1. Thanks to the Safeway patented optical system, which uses the possibility of tilting the reflectors with different inclinations, with this optic is possible to light wide frontal areas, resolving broad carriageways, roads with multiple lanes, parking spaces and very deep squares.

Codici prodotto / *Product codes*

4000K - CRI > 70

Codice Code CL I	Codice Code CL II	Numero LED Number of LED	Ottica Optic	Corrente di pilotaggio Led Current (mA)	W (LED+ DRIVER)	Flusso lum. nom. piastra LED Nominal flux LED plate (Lumen)	Flusso utile in uscita Useful output flux (Lumen)	Temp. ambiente Ambient temp. ta 35°C ta 55°C		Peso lordo Gross weight (kg)	Vol. (m ³)
57032	57141	49 LED	L10	530mA	81	14450	11840	•	•	16,60	0,0772
57033	57142	49 LED	L10	700mA	106	17850	14600	•	•	16,60	0,0772
57034	57143	56 LED	L10	530mA	90	16100	13180	•	•	16,60	0,0772
57035	57144	56 LED	L10	700mA	120	19900	16280	•	•	16,60	0,0772
57036	57145	63 LED	L10	530mA	105	18050	14770	•	•	16,60	0,0772
57037	57146	63 LED	L10	700mA	135	22300	18230	•	•	16,60	0,0772
57038	57147	70 LED	L10	530mA	117	19900	16270	•	•	16,60	0,0772
57039	57148	70 LED	L10	700mA	148	24050	19680	•	•	16,60	0,0772
57040	57149	77 LED	L10	530mA	125	21500	17570	•	•	16,60	0,0772
57041	57150	77 LED	L10	700mA	166	26750	21880	•	•	16,60	0,0772
57042	57151	84 LED	L10	530mA	135	23350	19800	•	•	16,60	0,0772
57043	57152	84 LED	L10	700mA	182	29100	23775	•	•	16,60	0,0772

Tecnologia LED Singlechip (2mmq)

Singlechip LED technology (2mmq)

57044	57153	20 LED	L10	700mA	168	29100	23790	•	•	16,80	0,0772
57045	57154	20 LED	L10	800mA	192	33100	27040	•	•	16,80	0,0772
57046	57155	20 LED	L10	900mA	216	35200	28780	•	•	16,80	0,0772
57047	57156	20 LED	L10	1000mA	240	38900	31780	•	•	16,80	0,0772
57048	57157	24 LED	L10	800mA	230	38900	31780	•	•	16,80	0,0772
57049	57158	24 LED	L10	900mA	259	41350	33780	•	•	16,80	0,0772
57050	57159	24 LED	L10	1000mA	288	45800	37420	•	•	16,80	0,0772
57051	57160	28 LED	L10	700mA	235	39150	31980	•	•	17,20	0,0772
57052	57161	28 LED	L10	800mA	268	44500	36380	•	•	17,20	0,0772
57053	57162	28 LED	L10	900mA	301	48050	39280	•	•	17,20	0,0772
57054	57163	28 LED	L10	1000mA	335	53300	43530	•	•	17,20	0,0772

Tecnologia LED Multichip (4X4mmq)

Multichip LED technology (4X4mmq)

I valori di flusso indicati devono essere considerati con una tolleranza del +/- 10%.
I valori di potenza elettrica indicati devono essere considerati con una tolleranza del +/- 7%.
I flussi luminosi indicati in tabella subiranno modifiche e miglioramenti in funzione della continua evoluzione tecnica dell'efficienza luminosa dei led.

*The flux values are to be considered with a tolerance of +/- 10%.
The wattages values are to be considered with a tolerance of +/- 7%.
The flows indicated in the table may be changed and improved according to the constant technical evolution of the light efficiency of the led.*



Curve fotometriche / Photometric data

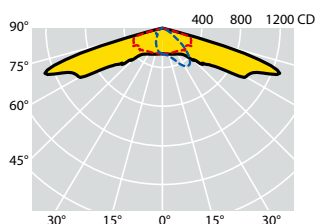

C max = 25°
LED 2mmq

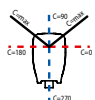
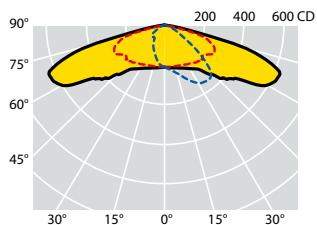
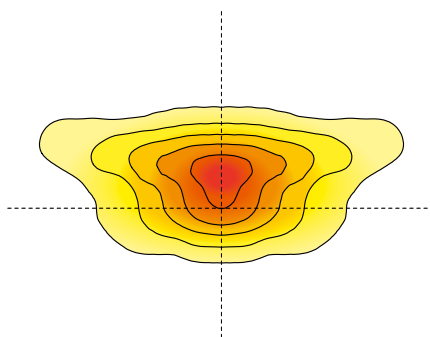

C max = 20°
LED 4mmq

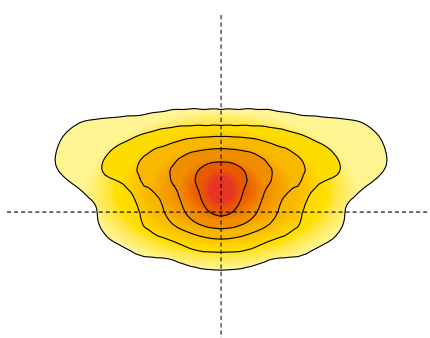

OTTICA W2:

Ottica stradale normalmente impiegata per tutte le categorie illuminotecniche, specialmente quando il rapporto tra l'altezza di installazione dell'apparecchio e la larghezza della carreggiata è maggiore di 0,85. L'ottica W2, presenta un notevole retroflusso che permette di risolvere installazioni con sbracci.

W2 OPTIC:

Street optic normally used for all categories lighting, especially when the installation height and the carriage width ratio is considerably greater than 0.85. The W2 optic features a notable back-flow that allows to solve installations with outreaches.

Codici prodotto / *Product codes*

4000K - CRI > 70

Codice Code CL I	Codice Code CL II	Numero LED Number of LED	Ottica Optic	Corrente di pilotaggio Led Current (mA)	W (LED+ DRIVER)	Flusso lum. nom. piastra LED Nominal flux LED plate (Lumen)	Flusso utile in uscita Useful output flux (Lumen)	Temp. ambiente Ambient temp. ta 35°C ta 55°C		Peso lordo Gross weight (kg)	Vol. (m ³)
57086	57195	64 LED	W2	530mA	107	18700	15600	•	•	16,60	0,0772
57087	57196	64 LED	W2	600mA	121	20500	17100	•		16,60	0,0772
57088	57197	64 LED	W2	700mA	137	23050	19240	•		16,60	0,0772
57089	57198	80 LED	W2	530mA	129	22850	19050	•	•	16,60	0,0772
57090	57199	80 LED	W2	600mA	146	24800	20700	•		16,60	0,0772
57091	57200	80 LED	W2	700mA	174	28400	23670	•		16,60	0,0772
Tecnologia LED Singlechip (2mmq)						<i>Singlechip LED technology (2mmq)</i>					
57092	57201	64 LED	W2	800mA	159	28400	23690	•		16,60	0,0772
57093	57202	64 LED	W2	900mA	181	31050	25900	•		16,60	0,0772
57094	57203	64 LED	W2	1000mA	203	34200	28500	•		16,60	0,0772
57095	57204	80 LED	W2	800mA	198	35050	29210	•		16,60	0,0772
57096	57205	80 LED	W2	900mA	225	37650	31410	•		16,60	0,0772
57097	57206	80 LED	W2	1000mA	252	41500	34620	•		16,60	0,0772
Tecnologia LED Singlechip (4mmq)						<i>Singlechip LED technology (4mmq)</i>					

I valori di flusso indicati devono essere considerati con una tolleranza del +/- 10%.
I valori di potenza elettrica indicati devono essere considerati con una tolleranza del +/- 7%.
I flussi luminosi indicati in tabella subiranno modifiche e miglioramenti in funzione della continua evoluzione tecnica dell'efficienza luminosa dei led.

*The flux values are to be considered with a tolerance of +/- 10%.
The wattages values are to be considered with a tolerance of +/- 7%.
The flows indicated in the table may be changed and improved according to the constant technical evolution of the light efficiency of the led.*



Curve fotometriche / Photometric data

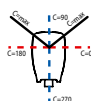
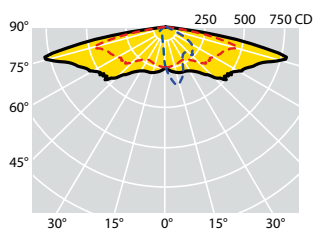

C max = 20°
LED 2mmq

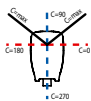
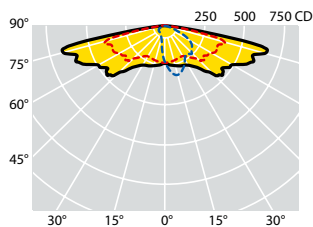
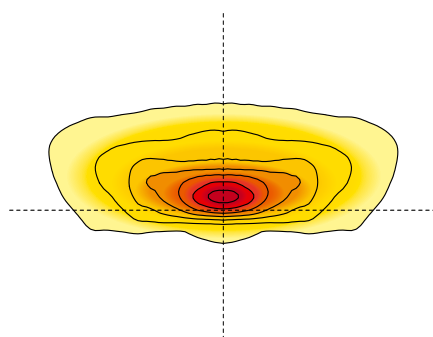

C max = 15°
LED 4mmq

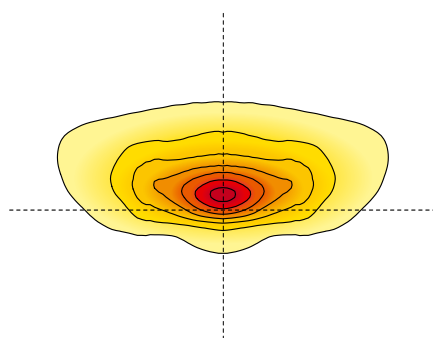

OTTICA S:

Ottica stradale normalmente impiegata per categorie illuminotecniche fino a M3. Tale ottica è particolarmente indicata in situazioni in cui il rapporto tra l'altezza di installazione e la larghezza della carreggiata è inferiore a 1. Risolve strade con interdistanze molto elevate e rapporto interdistanza / altezza d'installazione superiore a 5.

S OPTIC:

Street optic normally used for lighting categories up to M3. This optic is particularly suitable for situations where the installation height and the width of the carriageway ratio is less than 1. It is also appropriate for roads with very high interdistances and an interdistance / installation height ratio greater than 5.

Codici prodotto / *Product codes*

4000K - CRI > 70

Codice Code CL I	Codice Code CL II	Numero LED Number of LED	Ottica Optic	Corrente di pilotaggio Led Current (mA)	W (LED+ DRIVER)	Flusso lum. nom. piastra LED Nominal flux LED plate (Lumen)	Flusso utile in uscita Useful output flux (Lumen)	Temp. ambiente Ambient temp. ta 35°C ta 55°C		Peso lordo Gross weight (kg)	Vol. (m ³)
44930	44931	64 LED	S	530mA	107	18700	14660	•	•	16,60	0,0772
57082	57191	64 LED	S	600mA	121	20500	16070	•		16,60	0,0772
44932	44933	64 LED	S	700mA	137	23050	18080	•		16,60	0,0772
44934	44935	80 LED	S	530mA	129	22850	17900	•	•	16,60	0,0772
57083	57192	80 LED	S	600mA	146	24800	19450	•		16,60	0,0772
44936	44937	80 LED	S	700mA	174	28400	22240	•		16,60	0,0772
Tecnologia LED Singlechip (2mmq)						<i>Singlechip LED technology (2mmq)</i>					
44940	44941	64 LED	S	800mA	159	28400	22260	•		16,60	0,0772
57084	57193	64 LED	S	900mA	181	31050	24340	•		16,60	0,0772
44942	44943	64 LED	S	1000mA	203	34200	26790	•		16,60	0,0772
44944	44945	80 LED	S	800mA	198	35050	27450	•		16,60	0,0772
57085	57194	80 LED	S	900mA	225	37650	29520	•		16,60	0,0772
44946	44947	80 LED	S	1000mA	252	41500	32540	•		16,60	0,0772
Tecnologia LED Singlechip (4mmq)						<i>Singlechip LED technology (4mmq)</i>					

I valori di flusso indicati devono essere considerati con una tolleranza del +/- 10%.
I valori di potenza elettrica indicati devono essere considerati con una tolleranza del +/- 7%.
I flussi luminosi indicati in tabella subiranno modifiche e miglioramenti in funzione della continua evoluzione tecnica dell'efficienza luminosa dei led.

*The flux values are to be considered with a tolerance of +/- 10%.
The wattages values are to be considered with a tolerance of +/- 7%.
The flows indicated in the table may be changed and improved according to the constant technical evolution of the light efficiency of the led.*



Curve fotometriche / Photometric data

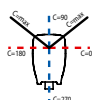
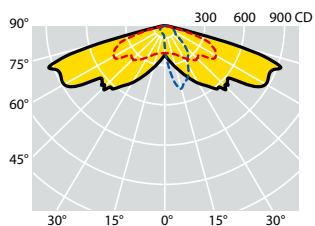

C max = 15°
LED 2mmq

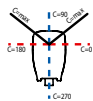
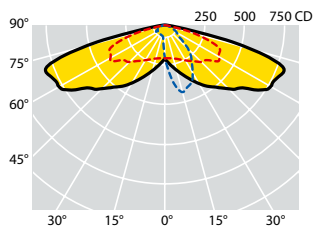
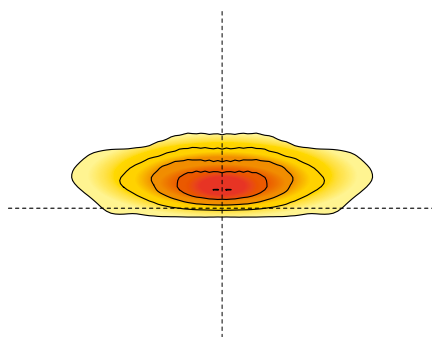

C max = 15°
LED 4mmq

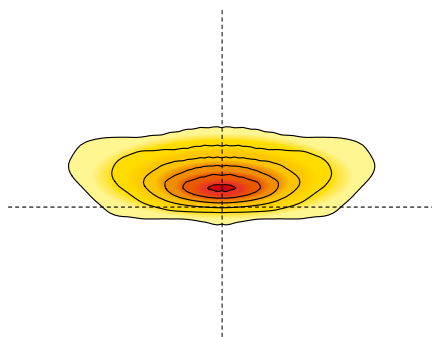

OTTICA V:

Ottica stradale particolarmente indicata in situazioni in cui il rapporto tra l'altezza di installazione e la larghezza della carreggiata è inferiore a 1.

VOPTIC:

Street optic particularly suitable for situations where the installation height and the width of the carriageway ratio is less than 1.

Codici prodotto / *Product codes*

4000K - CRI > 70

Codice Code CL I	Codice Code CL II	Numero LED Number of LED	Ottica Optic	Corrente di pilotaggio Led Current (mA)	W (LED+ DRIVER)	Flusso lum. nom. piastra LED Nominal flux LED plate (Lumen)	Flusso utile in uscita Useful output flux (Lumen)	Temp. ambiente Ambient temp. ta 35°C ta 55°C		Peso lordo Gross weight (kg)	Vol. (m ³)
44950	44951	64 LED	V	530mA	107	18700	15600	•	•	16,60	0,0772
57078	57187	64 LED	V	600mA	121	20500	17100	•		16,60	0,0772
44952	44953	64 LED	V	700mA	137	23050	19240	•		16,60	0,0772
44954	44955	80 LED	V	530mA	129	22850	19050	•	•	16,60	0,0772
57079	57188	80 LED	V	600mA	146	24800	20700	•		16,60	0,0772
44956	44957	80 LED	V	700mA	174	28400	23670	•		16,60	0,0772
Tecnologia LED Singlechip (2mmq)						<i>Singlechip LED technology (2mmq)</i>					
44960	44961	64 LED	V	800mA	159	28400	23690	•		16,60	0,0772
57080	57189	64 LED	V	900mA	181	31050	25900	•		16,60	0,0772
44962	44963	64 LED	V	1000mA	203	34200	28500	•		16,60	0,0772
44964	44965	80 LED	V	800mA	198	35050	29210	•		16,60	0,0772
57081	57190	80 LED	V	900mA	225	37650	31410	•		16,60	0,0772
44966	44967	80 LED	V	1000mA	252	41500	34620	•		16,60	0,0772
Tecnologia LED Singlechip (4mmq)						<i>Singlechip LED technology (4mmq)</i>					

I valori di flusso indicati devono essere considerati con una tolleranza del +/- 10%.
I valori di potenza elettrica indicati devono essere considerati con una tolleranza del +/- 7%.
I flussi luminosi indicati in tabella subiranno modifiche e miglioramenti in funzione della continua evoluzione tecnica dell'efficienza luminosa dei led.

*The flux values are to be considered with a tolerance of +/- 10%.
The wattages values are to be considered with a tolerance of +/- 7%.
The flows indicated in the table may be changed and improved according to the constant technical evolution of the light efficiency of the led.*



Curve fotometriche / Photometric data

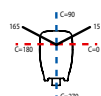
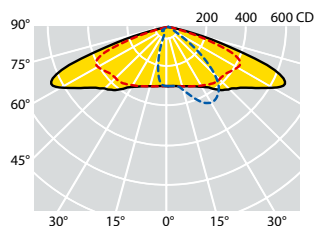

C max = 15°
LED MD

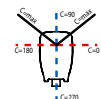
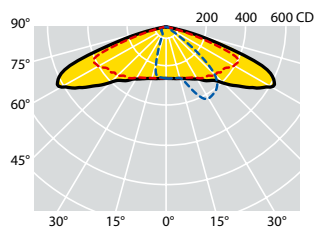
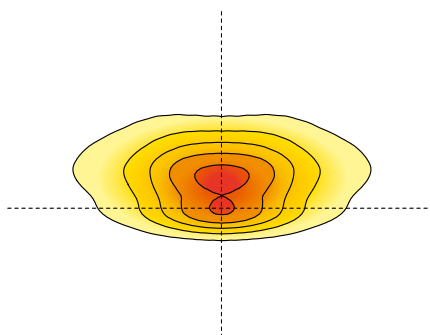

C max = 20°
LED 2mmq

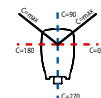
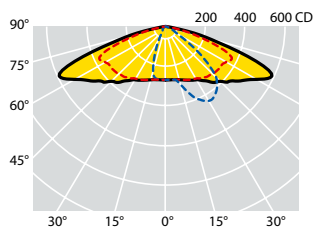
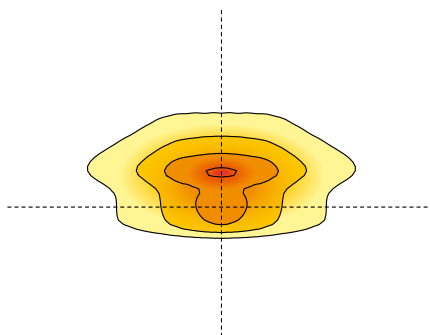

C max = 15°
LED 4x4mmq

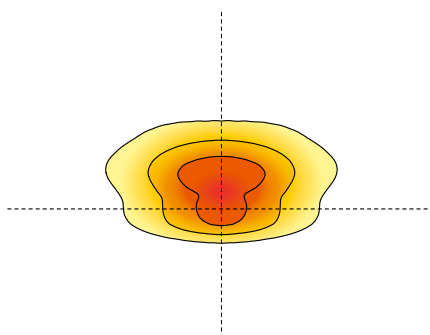

OTTICA AB1:

Ottica stradale normalmente impiegata per tutte le categorie illuminotecniche, specialmente quando il rapporto tra l'altezza di installazione dell'apparecchio e la larghezza della carreggiata è maggiore di 0,85. Risolve strade con rapporto tra l'interdistanza dei pali e l'altezza di installazione anche superiore a 4.

AB1 OPTIC:

Street optic normally used for all street illumination categories, especially when the relation between the installation height and the carriage width is greater than 0.85. This optic solves roads with a relationship between the poles distance and the installation height even higher than 4.

Codici prodotto / Product codes

4000K - CRI > 70

Codice Code CL I	Codice Code CL II	Numero LED Number of LED	Ottica Optic	Corrente di pilotaggio Led Current (mA)	W (LED+ DRIVER)	Flusso lum. nom. piastra LED Nominal flux LED plate (Lumen)	Flusso utile in uscita Useful output flux (Lumen)	Temp. ambiente Ambient temp. ta 35°C ta 55°C		Peso lordo Gross weight (kg)	Vol. (m ³)
72145	48920	24 LED	AB1	350mA	50	9300	7750	•		10,00	0,0514
72446	72400	24 LED	AB1	400mA	57	10450	8720	•		10,00	0,0514
72146	48921	30 LED	AB1	350mA	63	11700	9790	•		10,00	0,0514
72147	48922	30 LED	AB1	400mA	73	13000	10870	•		10,00	0,0514
72148	48923	36 LED	AB1	350mA	75	13800	11520	•		10,00	0,0514
72447	72401	36 LED	AB1	430mA	91	16100	13430	•		10,00	0,0514
72149	72134	36 LED	AB1	500mA	106	18150	15130	•		10,00	0,0514
Tecnologia LED MD						MDLED technology					
46033	46533	18 LED	AB1	530mA	29	4950	4150	•	•	10,60	0,0514
46034	46534	18 LED	AB1	700mA	39	6350	5330	•		10,60	0,0514
72564	72661	24 LED	AB1	600mA	44	7250	6070	•		10,85	0,0514
46050	46550	24 LED	AB1	700mA	52	8450	7080	•		10,85	0,0514
Tecnologia LED Singlechip (2mmq)						Singlechip LED technology (2mmq)					
72565	72662	6 LED	AB1	600mA	44	8150	6830	•	•	10,45	0,0514
72566	72663	6 LED	AB1	700mA	52	9400	7850	•	•	10,45	0,0514
46435	46959	6 LED	AB1	800mA	58	10400	8670	•	•	10,45	0,0514
72567	72664	6 LED	AB1	900mA	66	11350	9480	•		10,45	0,0514
46436	46960	6 LED	AB1	1000mA	73	12400	10340	•		10,45	0,0514
46461	46975	9 LED	AB1	800mA	85	15400	12850	•	•	10,50	0,0514
72568	72665	9 LED	AB1	900mA	98	16600	13870	•		10,50	0,0514
46462	46976	9 LED	AB1	1000mA	109	18200	15190	•		10,50	0,0514
46491	46983	12 LED	AB1	700mA	99	17950	14990	•	•	10,60	0,0514
72569	72666	12 LED	AB1	800mA	115	19300	16110	•	•	10,60	0,0514
72570	72667	12 LED	AB1	900mA	130	21250	17740	•		10,60	0,0514
46492	46984	12 LED	AB1	1000mA	144	23400	19510	•		10,60	0,0514
46421	46995	15 LED	AB1	700mA	122	21650	18050	•	•	10,75	0,0514
72571	72668	15 LED	AB1	800mA	140	23450	19580	•		10,75	0,0514
46422	46996	15 LED	AB1	900mA	158	26150	21820	•		10,75	0,0514
Tecnologia LED Multichip (4X4mmq)						Multichip LED technology (4X4mmq)					

I valori di flusso indicati devono essere considerati con una tolleranza del +/- 10%.
I valori di potenza elettrica indicati devono essere considerati con una tolleranza del +/- 7%.
I flussi luminosi indicati in tabella subiranno modifiche e miglioramenti in funzione della continua evoluzione tecnica dell'efficienza luminosa dei led.

The flux values are to be considered with a tolerance of +/- 10%.
The wattages values are to be considered with a tolerance of +/- 7%.
The flows indicated in the table may be changed and improved according to the constant technical evolution of the light efficiency of the led.



Curve fotometriche / Photometric data

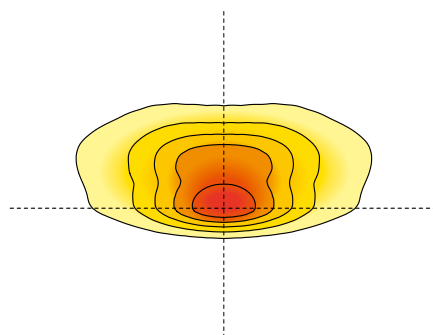
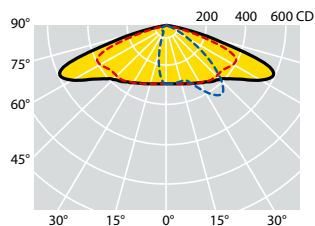

C max = 20°
LED MD

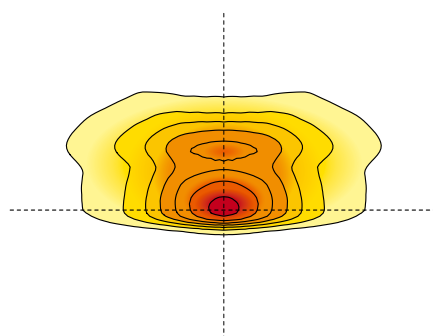
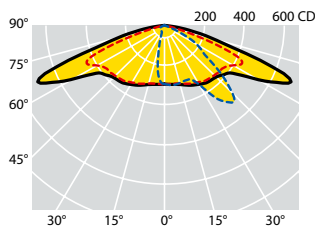

C max = 30°
LED 2mmq

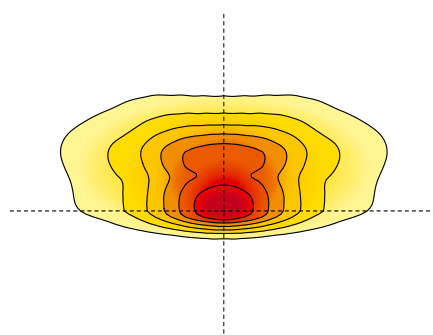
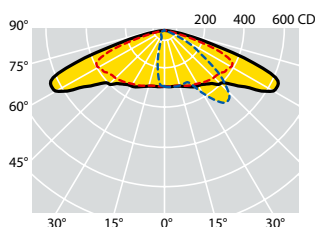

C max = 25°
LED 4x4mmq

OTTICA L10:

Ottica stradale normalmente impiegata per tutte le categorie illuminotecniche, specialmente quando il rapporto tra l'altezza di installazione dell'apparecchio e la larghezza della carreggiata è notevolmente maggiore di 1. Grazie al sistema ottico brevettato Safeway, che sfrutta la possibilità di inclinare i riflettori con angoli diversi, tale ottica permette di illuminare aree frontali molto ampie, risolvendo larghe carreggiate, strade a più corsie, parcheggi e piazzali molto profondi.

L10 OPTIC:

Street optic normally used for all categories lighting, especially when the installation height and the carriage width ratio is considerably greater than 1. Thanks to the Safeway patented optical system, which uses the possibility of tilting the reflectors with different inclinations, with this optic is possible to light wide frontal areas, resolving broad carriageways, roads with multiple lanes, parking spaces and very deep squares.

Codici prodotto / *Product codes*

4000K - CRI > 70

Codice Code CL I	Codice Code CL II	Numero LED Number of LED	Ottica Optic	Corrente di pilotaggio Led Current (mA)	W (LED+ DRIVER)	Flusso lum. nom. piastra LED Nominal flux LED plate (Lumen)	Flusso utile in uscita Useful output flux (Lumen)	Temp. ambiente Ambient temp. ta 35°C ta 55°C		Peso lordo Gross weight (kg)	Vol. (m ³)
72455	72409	24 LED	L10	350mA	50	9300	7590	•		10,00	0,0514
72460	72414	24 LED	L10	400mA	57	10450	8540	•		10,00	0,0514
72456	72410	30 LED	L10	350mA	63	11700	9590	•		10,00	0,0514
72457	72411	30 LED	L10	400mA	73	13000	10650	•		10,00	0,0514
72458	72412	36 LED	L10	350mA	75	13800	11300	•		10,00	0,0514
72461	72415	36 LED	L10	430mA	91	16100	13160	•		10,00	0,0514
72459	72413	36 LED	L10	500mA	106	18150	14830	•		10,00	0,0514
Tecnologia LED MD						<i>MDLED technology</i>					
72599	72696	18 LED	L10	530mA	29	4950	4070	•	•	10,60	0,0514
72600	72697	18 LED	L10	700mA	39	6350	5225	•		10,60	0,0514
72601	72698	24 LED	L10	600mA	44	7250	5950	•		10,85	0,0514
72602	72699	24 LED	L10	700mA	52	8450	6940	•		10,85	0,0514
Tecnologia LED Singlechip (2mmq)						<i>Singlechip LED technology (2mmq)</i>					
72603	72700	6 LED	L10	600mA	44	8150	6690	•	•	10,45	0,0514
72604	72701	6 LED	L10	700mA	52	9400	7700	•	•	10,45	0,0514
72605	72702	6 LED	L10	800mA	58	10400	8490	•	•	10,45	0,0514
72606	72703	6 LED	L10	900mA	66	11350	9290	•		10,45	0,0514
72607	72704	6 LED	L10	1000mA	73	12400	10130	•		10,45	0,0514
72608	72705	9 LED	L10	800mA	85	15400	12590	•	•	10,50	0,0514
72609	72706	9 LED	L10	900mA	98	16600	13590	•	•	10,50	0,0514
72610	72707	9 LED	L10	1000mA	109	18200	14890	•		10,50	0,0514
72611	72708	12 LED	L10	700mA	99	17950	14690	•		10,60	0,0514
72612	72709	12 LED	L10	800mA	115	19300	15790	•	•	10,60	0,0514
72613	72710	12 LED	L10	900mA	130	21250	17390	•		10,60	0,0514
72614	72711	12 LED	L10	1000mA	144	23400	19120	•		10,60	0,0514
72615	72712	15 LED	L10	700mA	122	21650	17690	•	•	10,75	0,0514
72616	72713	15 LED	L10	800mA	140	23450	19190	•		10,75	0,0514
72617	72714	15 LED	L10	900mA	158	26150	21380	•		10,75	0,0514
Tecnologia LED Multichip (4X4mmq)						<i>Multichip LED technology (4X4mmq)</i>					

I valori di flusso indicati devono essere considerati con una tolleranza del +/- 10%.
I valori di potenza elettrica indicati devono essere considerati con una tolleranza del +/- 7%.
I flussi luminosi indicati in tabella subiranno modifiche e miglioramenti in funzione della continua evoluzione tecnica dell'efficienza luminosa dei led.

*The flux values are to be considered with a tolerance of +/- 10%.
The wattages values are to be considered with a tolerance of +/- 7%.
The flows indicated in the table may be changed and improved according to the constant technical evolution of the light efficiency of the led.*



Curve fotometriche / Photometric data

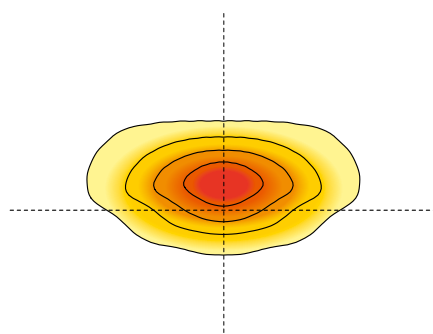
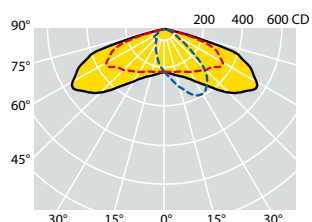

C max = 15°
LED MD

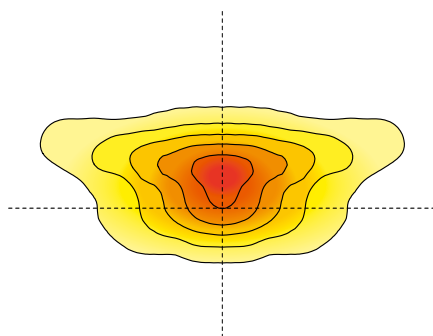
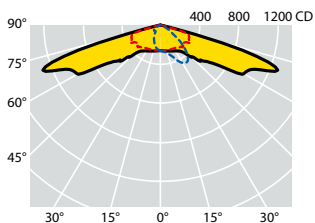

C max = 25°
LED 2mmq

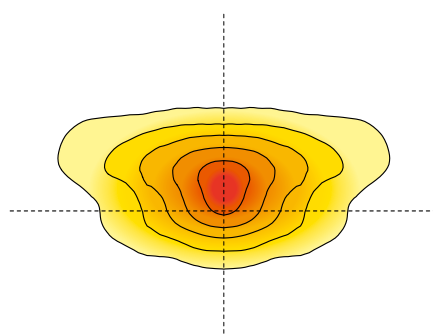
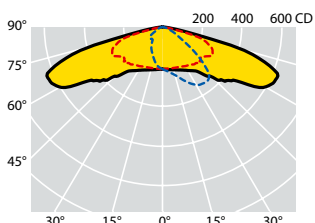

C max = 20°
LED 4mmq

OTTICA W2:

Ottica stradale normalmente impiegata per tutte le categorie illuminotecniche, specialmente quando il rapporto tra l'altezza di installazione dell'apparecchio e la larghezza della carreggiata è maggiore di 0,85. L'ottica W2, presenta un notevole retroflusso che permette di risolvere installazioni con sbracci.

W2 OPTIC:

Street optic normally used for all categories lighting, especially when the installation height and the carriage width ratio is considerably greater than 0.85. The W2 optic features a notable back-flow that allows to solve installations with outreaches.

Codici prodotto / Product codes

4000K - CRI > 70

Codice Code CL I	Codice Code CL II	Numero LED Number of LED	Ottica Optic	Corrente di pilotaggio Led Current (mA)	W (LED+ DRIVER)	Flusso lum. nom. piastra LED Nominal flux LED plate (Lumen)	Flusso utile in uscita Useful output flux (Lumen)	Temp. ambiente Ambient temp. ta 35°C ta 55°C		Peso lordo Gross weight (kg)	Vol. (m³)
72476	72430	36 LED	W2	200mA	43	8550	7140	•	•	10,00	0,0514
72477	72431	36 LED	W2	230mA	49	9650	8050	•	•	10,00	0,0514
72478	72432	36 LED	W2	280mA	60	11450	9580	•	•	10,00	0,0514
72479	72433	36 LED	W2	350mA	75	13850	11570	•	•	10,00	0,0514
72480	72434	36 LED	W2	480mA	103	17450	14580	•	•	10,00	0,0514
72481	72435	48 LED	W2	200mA	56	10900	9120	•	•	10,00	0,0514
72482	72436	48 LED	W2	350mA	100	18450	15400	•	•	10,00	0,0514
72483	72437	48 LED	W2	400mA	114	20450	17080	•	•	10,00	0,0514

Tecnologia LED MD

MDLED technology

72643	72740	24 LED	W2	530mA	40	6800	5700	•	•	10,00	0,0514
72644	72741	24 LED	W2	700mA	52	8600	7200	•	•	10,00	0,0514
72645	72742	36 LED	W2	530mA	58	9900	8250	•	•	10,10	0,0514
72646	72743	36 LED	W2	600mA	67	11000	9200	•	•	10,10	0,0514
72647	72744	36 LED	W2	700mA	76	12500	10450	•	•	10,10	0,0514

Tecnologia LED Singlechip (2mmq)

Singlechip LED technology (2mmq)

72648	72745	36 LED	W2	700mA	76	12950	10810	•	•	10,10	0,0514
72649	72746	36 LED	W2	800mA	88	14900	12440	•	•	10,10	0,0514
72650	72747	36 LED	W2	900mA	101	16800	14020	•	•	10,10	0,0514
72651	72748	36 LED	W2	1000mA	115	17900	14940	•	•	10,10	0,0514

Tecnologia LED Singlechip (4mmq)

Singlechip LED technology (4mmq)

I valori di flusso indicati devono essere considerati con una tolleranza del +/- 10%.
 I valori di potenza elettrica indicati devono essere considerati con una tolleranza del +/- 7%.
 I flussi luminosi indicati in tabella subiranno modifiche e miglioramenti in funzione della continua evoluzione tecnica dell'efficienza luminosa dei led.

The flux values are to be considered with a tolerance of +/- 10%.
 The wattages values are to be considered with a tolerance of +/- 7%.
 The flows indicated in the table may be changed and improved according to the constant technical evolution of the light efficiency of the led.



Curve fotometriche / Photometric data

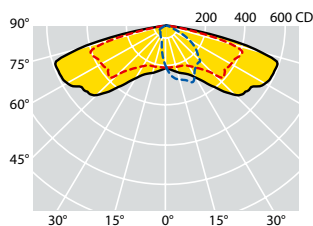

C max = 15°
LED MD

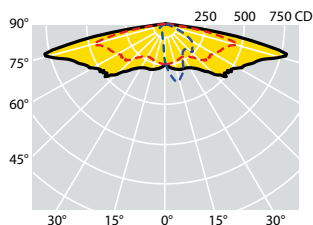
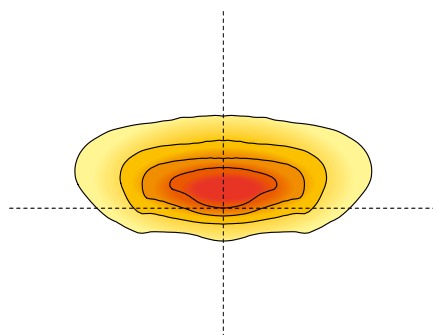

C max = 20°
LED 2mmq

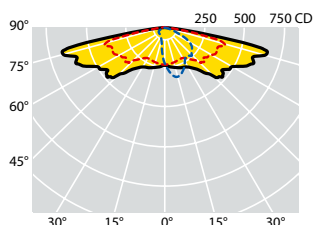
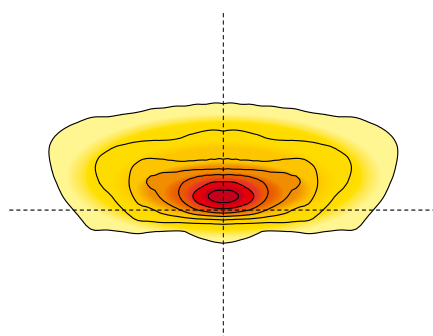

C max = 15°
LED 4mmq

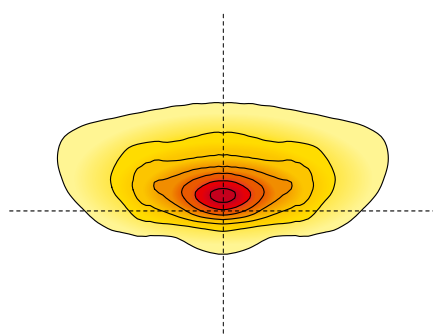

OTTICA S:

Ottica stradale normalmente impiegata per categorie illuminotecniche fino a M3. Tale ottica è particolarmente indicata in situazioni in cui il rapporto tra l'altezza di installazione e la larghezza della carreggiata è inferiore a 1. Risolve strade con interdistanze molto elevate e rapporto interdistanza / altezza d'installazione superiore a 5.

SOPTIC:

Street optic normally used for lighting categories up to M3. This optic is particularly suitable for situations where the installation height and the width of the carriageway ratio is less than 1. It is also appropriate for roads with very high interdistances and an interdistance / installation height ratio greater than 5.

Codici prodotto / *Product codes*

4000K - CRI > 70

Codice Code CL I	Codice Code CL II	Numero LED Number of LED	Ottica Optic	Corrente di pilotaggio Led Current (mA)	W (LED+ DRIVER)	Flusso lum. nom. piastra LED Nominal flux LED plate (Lumen)	Flusso utile in uscita Useful output flux (Lumen)	Temp. ambiente Ambient temp.		Peso lordo Gross weight (kg)	Vol. (m ³)
								ta 35°C	ta 55°C		
72150	72135	36 LED	S	200mA	43	8550	6730	•	•	10,00	0,0514
72152	48928	36 LED	S	230mA	49	9650	7590	•	•	10,00	0,0514
72154	72137	36 LED	S	280mA	60	11450	9020	•	•	10,00	0,0514
72156	48929	36 LED	S	350mA	75	13850	10910	•	•	10,00	0,0514
72158	72139	36 LED	S	480mA	103	17450	13820	•	•	10,00	0,0514
72224	48930	48 LED	S	200mA	56	10900	8670	•	•	10,00	0,0514
72226	48931	48 LED	S	350mA	100	18450	14280	•	•	10,00	0,0514
72324	72323	48 LED	S	400mA	114	20450	15860	•	•	10,00	0,0514

Tecnologia LED MD

MD LED technology

48461	48462	24 LED	S	530mA	40	6800	5350	•	•	10,00	0,0514
48463	48464	24 LED	S	700mA	52	8600	6760	•	•	10,00	0,0514
48467	48468	36 LED	S	530mA	58	9900	7750	•	•	10,10	0,0514
72640	72737	36 LED	S	600mA	67	11000	8640	•	•	10,10	0,0514
48469	48470	36 LED	S	700mA	76	12500	9820	•	•	10,10	0,0514

Tecnologia LED Singlechip (2mmq)

Singlechip LED technology (2mmq)

72641	72738	36 LED	S	700mA	76	12950	10150	•	•	10,10	0,0514
48520	48521	36 LED	S	800mA	88	14900	11680	•	•	10,10	0,0514
72642	72739	36 LED	S	900mA	101	16800	13170	•	•	10,10	0,0514
48522	48523	36 LED	S	1000mA	115	17900	13970	•	•	10,10	0,0514

Tecnologia LED Singlechip (4mmq)

Singlechip LED technology (4mmq)

I valori di flusso indicati devono essere considerati con una tolleranza del +/- 10%.
 I valori di potenza elettrica indicati devono essere considerati con una tolleranza del +/- 7%.
 I flussi luminosi indicati in tabella subiranno modifiche e miglioramenti in funzione della continua evoluzione tecnica dell'efficienza luminosa dei led.

*The flux values are to be considered with a tolerance of +/- 10%.
 The wattages values are to be considered with a tolerance of +/- 7%.
 The flows indicated in the table may be changed and improved according to the constant technical evolution of the light efficiency of the led.*



Curve fotometriche / Photometric data

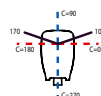
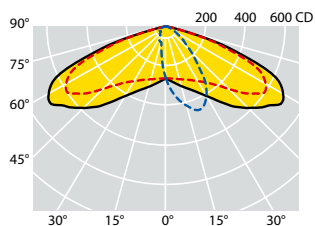

C max = 10°
LED MD

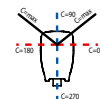
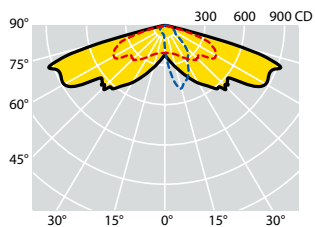
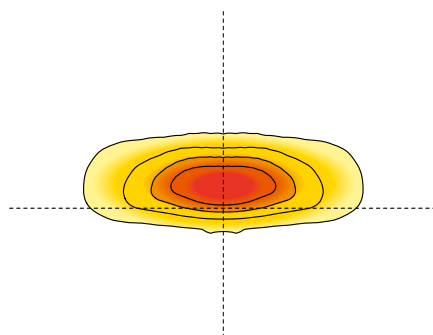

C max = 15°
LED 2mmq

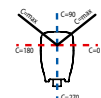
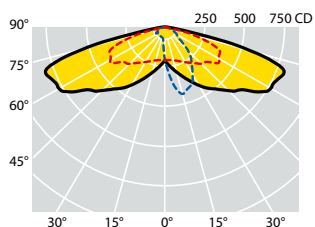
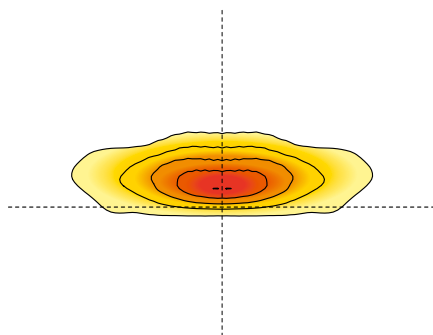

C max = 15°
LED 4mmq

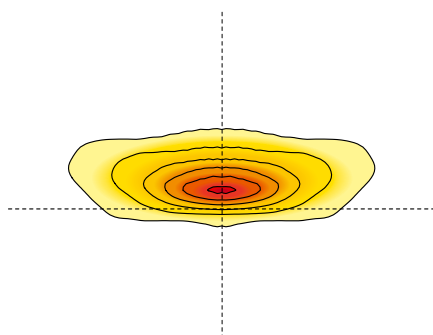

OTTICA V:

Ottica stradale particolarmente indicata in situazioni in cui il rapporto tra l'altezza di installazione e la larghezza della carreggiata è inferiore a 1.

VOPTIC:

Street optic particularly suitable for situations where the installation height and the width of the carriageway ratio is less than 1.

Codici prodotto / *Product codes*

4000K - CRI > 70

Codice Code CL I	Codice Code CL II	Numero LED Number of LED	Ottica Optic	Corrente di pilotaggio Led Current (mA)	W (LED+ DRIVER)	Flusso lum. nom. piastra LED Nominal flux LED plate (Lumen)	Flusso utile in uscita Useful output flux (Lumen)	Temp. ambiente Ambient temp. ta 35°C ta 55°C		Peso lordo Gross weight (kg)	Vol. (m ³)
72151	72136	36 LED	V	200mA	43	8550	7140	•	•	10,00	0,0514
72153	48924	36 LED	V	230mA	49	9650	8050	•	•	10,00	0,0514
72155	72138	36 LED	V	280mA	60	11450	9580	•	•	10,00	0,0514
72157	48925	36 LED	V	350mA	75	13850	11570	•	•	10,00	0,0514
72159	72140	36 LED	V	480mA	103	17450	14580	•	•	10,00	0,0514
72225	48926	48 LED	V	200mA	56	10900	9120	•	•	10,00	0,0514
72227	48927	48 LED	V	350mA	100	18450	15400	•	•	10,00	0,0514
72326	72325	48 LED	V	400mA	114	20450	17080	•	•	10,00	0,0514

Tecnologia LED MD

MD LED technology

48530	48531	24 LED	V	530mA	40	6800	5700	•	•	10,00	0,0514
48532	48533	24 LED	V	700mA	52	8600	7200	•	•	10,00	0,0514
48534	48535	36 LED	V	530mA	58	9900	8250	•	•	10,10	0,0514
72637	72734	36 LED	V	600mA	67	11000	9200	•	•	10,10	0,0514
48536	48537	36 LED	V	700mA	76	12500	10450	•	•	10,10	0,0514

Tecnologia LED Singlechip (2mmq)

Singlechip LED technology (2mmq)

72638	72735	36 LED	V	700mA	76	12950	10810	•	•	10,10	0,0514
48540	48541	36 LED	V	800mA	88	14900	12440	•	•	10,10	0,0514
72639	72736	36 LED	V	900mA	101	16800	14020	•	•	10,10	0,0514
48542	48543	36 LED	V	1000mA	115	17900	14940	•	•	10,10	0,0514

Tecnologia LED Singlechip (4mmq)

Singlechip LED technology (4mmq)

I valori di flusso indicati devono essere considerati con una tolleranza del +/- 10%.
I valori di potenza elettrica indicati devono essere considerati con una tolleranza del +/- 7%.
I flussi luminosi indicati in tabella subiranno modifiche e miglioramenti in funzione della continua evoluzione tecnica dell'efficienza luminosa dei led.

*The flux values are to be considered with a tolerance of +/- 10%.
The wattages values are to be considered with a tolerance of +/- 7%.
The flows indicated in the table may be changed and improved according to the constant technical evolution of the light efficiency of the led.*



Curve fotometriche / Photometric data

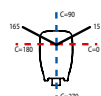
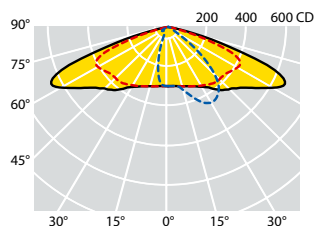

C max = 15°
LED MD

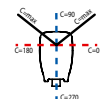
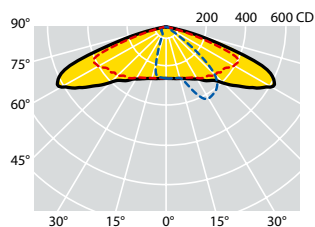
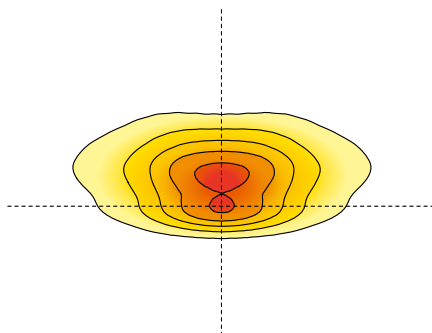

C max = 20°
LED 2mmq

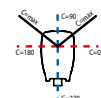
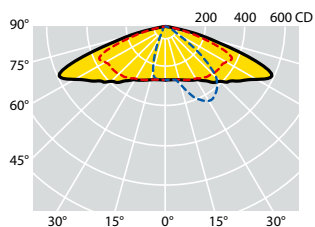
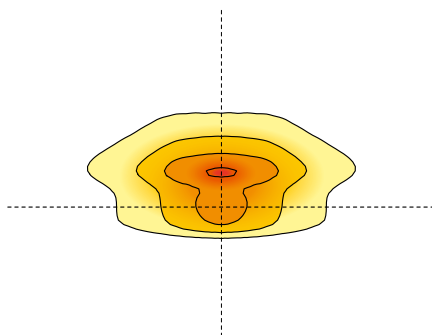

C max = 15°
LED 4x4mmq

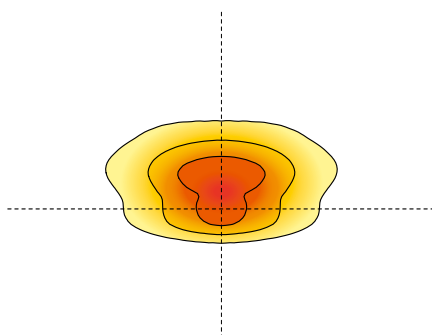

OTTICA AB1:

Ottica stradale normalmente impiegata per tutte le categorie illuminotecniche, specialmente quando il rapporto tra l'altezza di installazione dell'apparecchio e la larghezza della carreggiata è maggiore di 0,85. Risolve strade con rapporto tra l'interdistanza dei pali e l'altezza di installazione anche superiore a 4.

AB1 OPTIC:

Street optic normally used for all street illumination categories, especially when the relation between the installation height and the carriage width is greater than 0.85. This optic solves roads with a relationship between the poles distance and the installation height even higher than 4.

Codici prodotto / Product codes

4000K - CRI > 70

Codice Code CL I	Codice Code CL II	Numero LED Number of LED	Ottica Optic	Corrente di pilotaggio Led Current (mA)	W (LED+ DRIVER)	Flusso lum. nom. piastra LED Nominal flux LED plate (Lumen)	Flusso utile in uscita Useful output flux (Lumen)	Temp. ambiente Ambient temp. ta 35°C ta 55°C		Peso lordo Gross weight (kg)	Vol. (m ³)
63676	63603	10 LED	AB1	200mA	12	2250	1910	•	•	6,80	0,0293
63677	63604	10 LED	AB1	280mA	17	3150	2650	•	•	6,80	0,0293
63334	63270	10 LED	AB1	350mA	22	3850	3240	•	•	6,80	0,0293
63678	63605	15 LED	AB1	260mA	24	4250	3570	•	•	6,80	0,0293
63335	63271	15 LED	AB1	320mA	30	5150	4320	•	•	6,80	0,0293
63336	63272	20 LED	AB1	280mA	34	6200	5190	•	•	6,80	0,0293
63337	63273	20 LED	AB1	350mA	43	7600	6370	•	•	6,80	0,0293
63352	63351	20 LED	AB1	410mA	51	8700	7290	•	•	6,80	0,0293
63338	63274	25 LED	AB1	350mA	56	9700	8100	•	•	6,80	0,0293
63339	63275	25 LED	AB1	400mA	62	10700	8920	•	•	6,80	0,0293
63340	63307	25 LED	AB1	450mA	69	11800	9840	•	•	6,80	0,0293

Tecnologia LED MD

MDLED technology

63112	63113	10 LED	AB1	350mA	11	1850	1560	•	•	6,80	0,0293
63000	63001	10 LED	AB1	530mA	17	2800	2370	•	•	6,80	0,0293
63808	63890	15 LED	AB1	500mA	24	3800	3190	•	•	6,80	0,0293
63008	63009	20 LED	AB1	530mA	33	5350	4480	•	•	6,90	0,0293
63809	63891	25 LED	AB1	500mA	39	6200	5180	•	•	6,95	0,0293

Tecnologia LED Singlechip (2mmq)

Singlechip LED technology (2mmq)

63810	63892	6 LED	AB1	500mA	37	6600	5500	•	•	6,80	0,0293
63811	63893	6 LED	AB1	600mA	45	7750	6470	•	•	6,80	0,0293
63124	63125	6 LED	AB1	700mA	52	8550	7140	•	•	6,80	0,0293
63024	63025	6 LED	AB1	800mA	58	9300	7750	•	•	6,80	0,0293
63812	63894	6 LED	AB1	900mA	65	10300	8610	•	•	6,80	0,0293
63813	63895	9 LED	AB1	600mA	64	10600	8870	•	•	6,80	0,0293
63120	63121	9 LED	AB1	700mA	75	12100	10090	•	•	6,80	0,0293

Tecnologia LED Multichip (4X4mmq)

Multichip LED technology (4X4mmq)

I valori di flusso indicati devono essere considerati con una tolleranza del +/- 10%.
I valori di potenza elettrica indicati devono essere considerati con una tolleranza del +/- 7%.
I flussi luminosi indicati in tabella subiranno modifiche e miglioramenti in funzione della continua evoluzione tecnica dell'efficienza luminosa dei led.

The flux values are to be considered with a tolerance of +/- 10%.
The wattages values are to be considered with a tolerance of +/- 7%.
The flows indicated in the table may be changed and improved according to the constant technical evolution of the light efficiency of the led.



Curve fotometriche / Photometric data

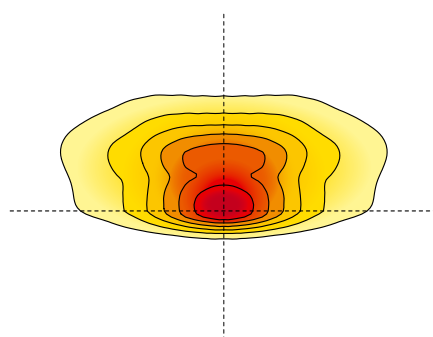
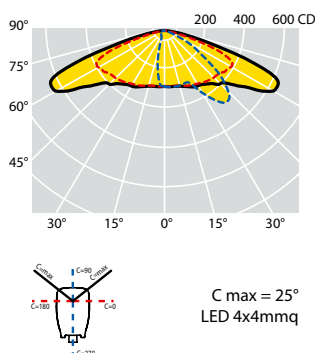
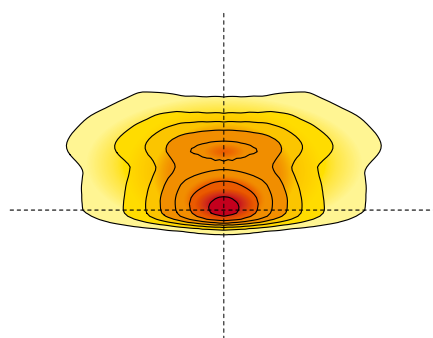
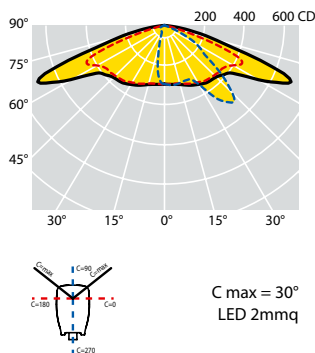
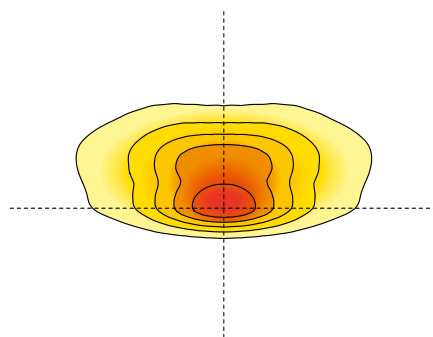
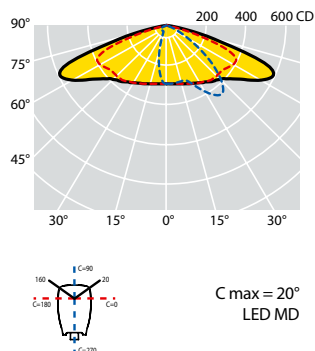

OTTICA L10:

Ottica stradale normalmente impiegata per tutte le categorie illuminotecniche, specialmente quando il rapporto tra l'altezza di installazione dell'apparecchio e la larghezza della carreggiata è notevolmente maggiore di 1. Grazie al sistema ottico brevettato Safeway, che sfrutta la possibilità di inclinare i riflettori con angoli diversi, tale ottica permette di illuminare aree frontali molto ampie, risolvendo larghe carreggiate, strade a più corsie, parcheggi e piazzali molto profondi.

L10 OPTIC:

Street optic normally used for all categories lighting, especially when the installation height and the carriage width ratio is considerably greater than 1. Thanks to the Safeway patented optical system, which uses the possibility of tilting the reflectors with different inclinations, with this optic is possible to light wide frontal areas, resolving broad carriageways, roads with multiple lanes, parking spaces and very deep squares.

Codici prodotto / *Product codes*

4000K - CRI > 70

Codice Code CL I	Codice Code CL II	Numero LED Number of LED	Ottica Optic	Corrente di pilotaggio Led Current (mA)	W (LED+ DRIVER)	Flusso lum. nom. piastra LED Nominal flux LED plate (Lumen)	Flusso utile in uscita Useful output flux (Lumen)	Temp. ambiente Ambient temp. ta 35°C ta 55°C		Peso lordo Gross weight (kg)	Vol. (m ³)
63698	63625	10 LED	L10	200mA	12	2250	1910	•	•	6,80	0,0293
63699	63626	10 LED	L10	280mA	17	3150	2650	•	•	6,80	0,0293
63690	63617	10 LED	L10	350mA	22	3850	3240	•	•	6,80	0,0293
63700	63627	15 LED	L10	260mA	24	4250	3570	•	•	6,80	0,0293
63691	63618	15 LED	L10	320mA	30	5150	4320	•	•	6,80	0,0293
63692	63619	20 LED	L10	280mA	34	6200	5190	•	•	6,80	0,0293
63693	63620	20 LED	L10	350mA	43	7600	6370	•	•	6,80	0,0293
63694	63621	20 LED	L10	410mA	51	8700	7290	•	•	6,80	0,0293
63695	63622	25 LED	L10	350mA	56	9700	8100	•	•	6,80	0,0293
63696	63623	25 LED	L10	400mA	62	10700	8920	•	•	6,80	0,0293
63697	63624	25 LED	L10	450mA	69	11800	9840	•	•	6,80	0,0293

Tecnologia LED MD

MDLED technology

63832	63914	10 LED	L10	350mA	11	1850	1530	•	•	6,80	0,0293
63833	63915	10 LED	L10	530mA	17	2800	2320	•	•	6,80	0,0293
63834	63916	15 LED	L10	500mA	24	3800	3125	•	•	6,80	0,0293
63835	63917	20 LED	L10	530mA	33	5350	4390	•	•	6,90	0,0293
63836	63918	25 LED	L10	500mA	39	6200	5080	•	•	6,95	0,0293

Tecnologia LED Singlechip (2mmq)

Singlechip LED technology (2mmq)

63837	63919	6 LED	L10	500mA	37	6600	5500	•	•	6,80	0,0293
63838	63920	6 LED	L10	600mA	45	7750	6470	•	•	6,80	0,0293
63839	63921	6 LED	L10	700mA	52	8550	7140	•	•	6,80	0,0293
63840	63922	6 LED	L10	800mA	58	9300	7750	•	•	6,80	0,0293
63841	63923	6 LED	L10	900mA	65	10300	8610	•	•	6,80	0,0293
63842	63924	9 LED	L10	600mA	64	10600	8870	•	•	6,80	0,0293
63843	63925	9 LED	L10	700mA	75	12100	10090	•	•	6,80	0,0293

Tecnologia LED Multichip (4X4mmq)

Multichip LED technology (4X4mmq)

I valori di flusso indicati devono essere considerati con una tolleranza del +/- 10%.
I valori di potenza elettrica indicati devono essere considerati con una tolleranza del +/- 7%.
I flussi luminosi indicati in tabella subiranno modifiche e miglioramenti in funzione della continua evoluzione tecnica dell'efficienza luminosa dei led.

*The flux values are to be considered with a tolerance of +/- 10%.
The wattages values are to be considered with a tolerance of +/- 7%.
The flows indicated in the table may be changed and improved according to the constant technical evolution of the light efficiency of the led.*



Curve fotometriche / Photometric data

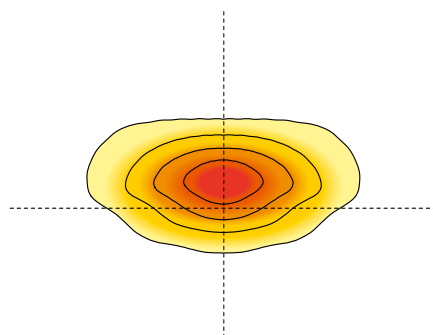
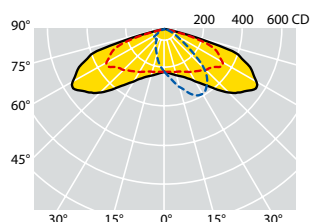

C max = 15°
LED MD

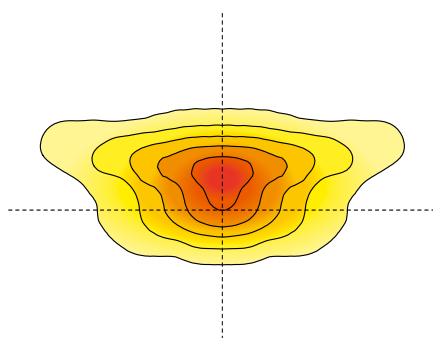
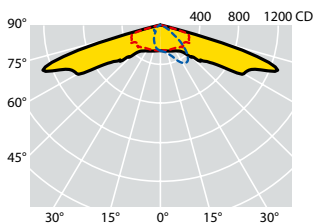

C max = 25°
LED 2mmq

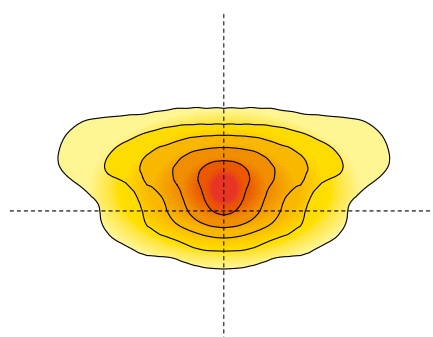
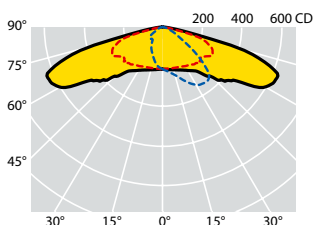

C max = 20°
LED 4mmq

OTTICA W2:

Ottica stradale normalmente impiegata per tutte le categorie illuminotecniche, specialmente quando il rapporto tra l'altezza di installazione dell'apparecchio e la larghezza della carreggiata è maggiore di 0,85. L'ottica W2, presenta un notevole retroflusso che permette di risolvere installazioni con sbracci.

W2 OPTIC:

Street optic normally used for all categories lighting, especially when the installation height and the carriage width ratio is considerably greater than 0.85. The W2 optic features a notable back-flow that allows to solve installations with outreaches.

Codici prodotto / *Product codes*

4000K - CRI > 70

Codice Code CL I	Codice Code CL II	Numero LED Number of LED	Ottica Optic	Corrente di pilotaggio Led Current (mA)	W (LED+ DRIVER)	Flusso lum. nom. piastra LED Nominal flux LED plate (Lumen)	Flusso utile in uscita Useful output flux (Lumen)	Temp. ambiente Ambient temp. ta 35°C ta 55°C		Peso lordo Gross weight (kg)	Vol. (m ³)
63738	63665	8 LED	W2	200mA	10	1950	1630	•	•	6,80	0,0293
63739	63666	8 LED	W2	300mA	15	2800	2370	•	•	6,80	0,0293
63731	63658	16 LED	W2	200mA	20	3900	3260	•	•	6,80	0,0293
63736	63663	16 LED	W2	250mA	25	4650	3910	•	•	6,80	0,0293
63737	63664	16 LED	W2	300mA	30	5550	4640	•	•	6,80	0,0293
63732	63659	16 LED	W2	350mA	35	6400	5350	•	•	6,80	0,0293
63733	63660	24 LED	W2	280mA	44	8200	6850	•	•	6,80	0,0293
63734	63661	24 LED	W2	400mA	59	10550	8830	•	•	6,80	0,0293
63735	63662	24 LED	W2	455mA	67	11950	9960	•	•	6,80	0,0293

Tecnologia LED MD

MD LED technology

63868	63950	8 LED	W2	530mA	13	2200	1870	•	•	6,80	0,0293
63869	63951	8 LED	W2	700mA	18	2900	2420	•	•	6,80	0,0293
63870	63952	16 LED	W2	530mA	26	4500	3770	•	•	6,80	0,0293
63871	63953	16 LED	W2	700mA	35	5750	4820	•	•	6,80	0,0293
63872	63954	24 LED	W2	530mA	40	6800	5690	•	•	6,80	0,0293
63873	63955	24 LED	W2	700mA	52	8500	7120	•	•	6,80	0,0293

Tecnologia LED Singlechip (2mmq)

Singlechip LED technology (2mmq)

63874	63956	16 LED	W2	750mA	37	6200	5200	•	•	6,80	0,0293
63875	63957	16 LED	W2	800mA	40	6600	5500	•	•	6,80	0,0293
63876	63958	16 LED	W2	900mA	45	7300	6120	•	•	6,80	0,0293
63877	63959	24 LED	W2	700mA	52	8700	7290	•	•	6,80	0,0293
63878	63960	24 LED	W2	800mA	59	9850	8210	•	•	6,80	0,0293

Tecnologia LED Singlechip (4mmq)

Singlechip LED technology (4mmq)

I valori di flusso indicati devono essere considerati con una tolleranza del +/- 10%.
I valori di potenza elettrica indicati devono essere considerati con una tolleranza del +/- 7%.
I flussi luminosi indicati in tabella subiranno modifiche e miglioramenti in funzione della continua evoluzione tecnica dell'efficienza luminosa dei led.

*The flux values are to be considered with a tolerance of +/- 10%.
The wattages values are to be considered with a tolerance of +/- 7%.
The flows indicated in the table may be changed and improved according to the constant technical evolution of the light efficiency of the led.*



Curve fotometriche / Photometric data

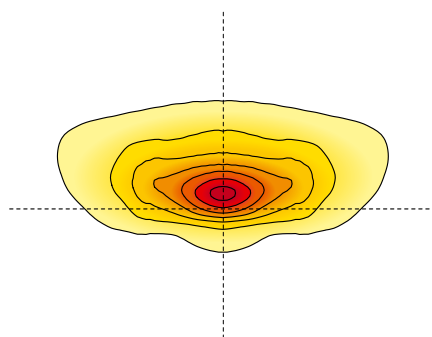
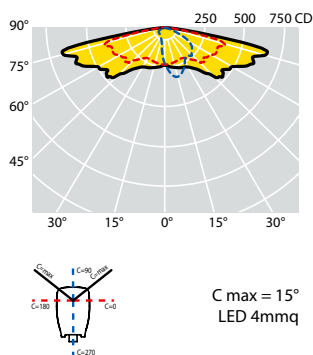
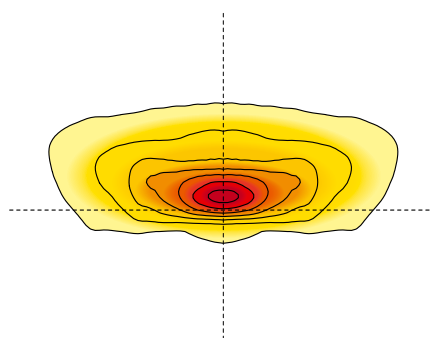
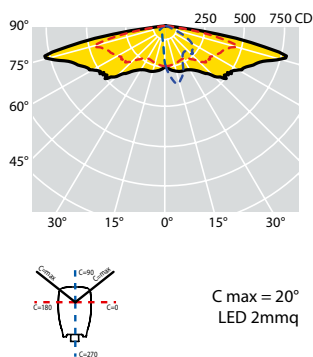
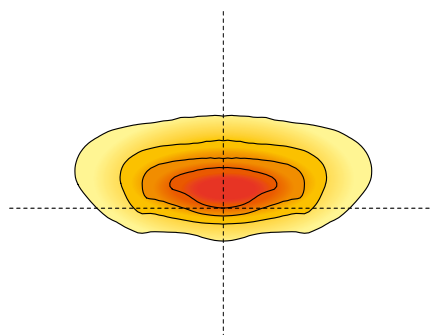
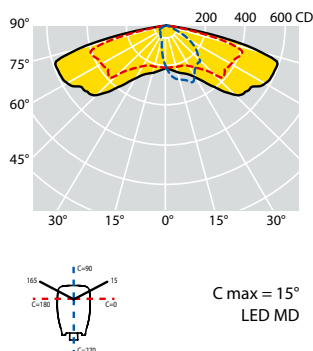

OTTICA S:

Ottica stradale normalmente impiegata per categorie illuminotecniche fino a M3. Tale ottica è particolarmente indicata in situazioni in cui il rapporto tra l'altezza di installazione e la larghezza della carreggiata è inferiore a 1. Risolve strade con interdistanze molto elevate e rapporto interdistanza / altezza d'installazione superiore a 5.

SOPTIC:

Street optic normally used for lighting categories up to M3. This optic is particularly suitable for situations where the installation height and the width of the carriageway ratio is less than 1. It is also appropriate for roads with very high interdistances and an interdistance / installation height ratio greater than 5.

Codici prodotto / *Product codes*

4000K - CRI > 70

Codice Code CL I	Codice Code CL II	Numero LED Number of LED	Ottica Optic	Corrente di pilotaggio Led Current (mA)	W (LED+ DRIVER)	Flusso lum. nom. piastra LED Nominal flux LED plate (Lumen)	Flusso utile in uscita Useful output flux (Lumen)	Temp. ambiente Ambient temp. ta 35°C ta 55°C		Peso lordo Gross weight (kg)	Vol. (m ³)
63729	63656	8 LED	S	200mA	10	1950	1530	•	•	6,80	0,0293
63730	63657	8 LED	S	300mA	15	2800	2230	•	•	6,80	0,0293
63341	63279	16 LED	S	200mA	20	3900	3060	•	•	6,80	0,0293
63727	63654	16 LED	S	250mA	25	4650	3670	•	•	6,80	0,0293
63728	63655	16 LED	S	300mA	30	5550	4350	•	•	6,80	0,0293
63343	63280	16 LED	S	350mA	35	6400	5100	•	•	6,80	0,0293
63345	63308	24 LED	S	280mA	44	8200	6420	•	•	6,80	0,0293
63347	63281	24 LED	S	400mA	59	10550	8210	•	•	6,80	0,0293
63349	63311	24 LED	S	455mA	67	11950	9230	•	•	6,80	0,0293

Tecnologia LED MD

MDLED technology

63080	63081	8 LED	S	530mA	13	2200	1750	•	•	6,80	0,0293
63082	63083	8 LED	S	700mA	18	2900	2270	•	•	6,80	0,0293
63084	63085	16 LED	S	530mA	26	4500	3540	•	•	6,80	0,0293
63086	63087	16 LED	S	700mA	35	5750	4530	•	•	6,80	0,0293
63088	63089	24 LED	S	530mA	40	6800	5340	•	•	6,80	0,0293
63090	63091	24 LED	S	700mA	52	8500	6690	•	•	6,80	0,0293

Tecnologia LED Singlechip (2mmq)

Singlechip LED technology (2mmq)

63864	63946	16 LED	S	750mA	37	6200	4880	•	•	6,80	0,0293
63218	63219	16 LED	S	800mA	40	6600	5170	•	•	6,80	0,0293
63865	63947	16 LED	S	900mA	45	7300	5750	•	•	6,80	0,0293
63866	63948	24 LED	S	700mA	52	8700	6850	•	•	6,80	0,0293
63092	63093	24 LED	S	800mA	59	9850	7710	•	•	6,80	0,0293

Tecnologia LED Singlechip (4mmq)

Singlechip LED technology (4mmq)

I valori di flusso indicati devono essere considerati con una tolleranza del +/- 10%.
I valori di potenza elettrica indicati devono essere considerati con una tolleranza del +/- 7%.
I flussi luminosi indicati in tabella subiranno modifiche e miglioramenti in funzione della continua evoluzione tecnica dell'efficienza luminosa dei led.

*The flux values are to be considered with a tolerance of +/- 10%.
The wattages values are to be considered with a tolerance of +/- 7%.
The flows indicated in the table may be changed and improved according to the constant technical evolution of the light efficiency of the led.*



Curve fotometriche / Photometric data

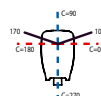
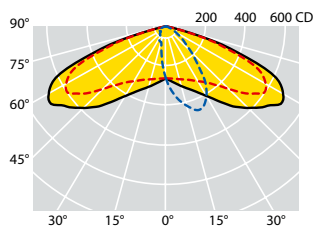

C max = 10°
LED MD

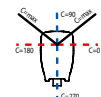
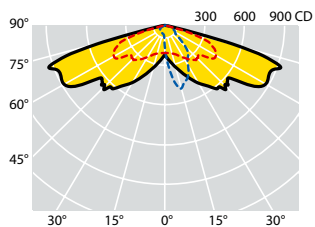
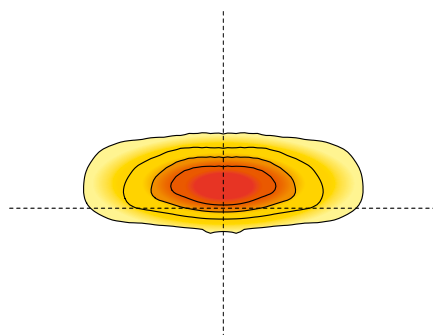

C max = 15°
LED 2mmq

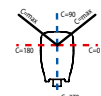
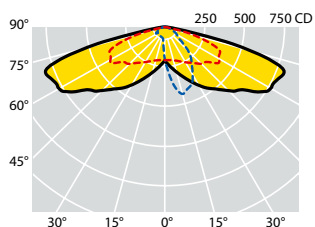
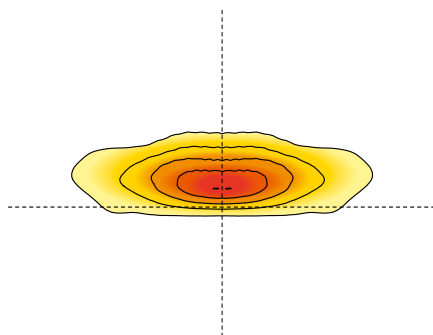

C max = 15°
LED 4mmq

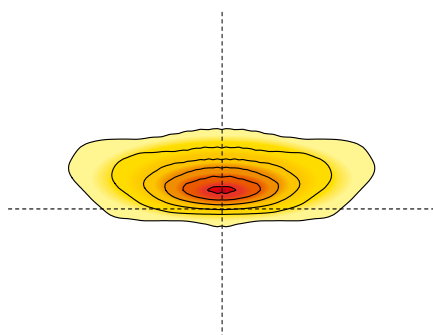

OTTICA V:

Ottica stradale particolarmente indicata in situazioni in cui il rapporto tra l'altezza di installazione e la larghezza della carreggiata è inferiore a 1.

VOPTIC:

Street optic particularly suitable for situations where the installation height and the width of the carriageway ratio is less than 1.

Codici prodotto / *Product codes*

4000K - CRI > 70

Codice Code CL I	Codice Code CL II	Numero LED Number of LED	Ottica Optic	Corrente di pilotaggio Led Current (mA)	W (LED+ DRIVER)	Flusso lum. nom. piastra LED Nominal flux LED plate (Lumen)	Flusso utile in uscita Useful output flux (Lumen)	Temp. ambiente Ambient temp. ta 35°C ta 55°C		Peso lordo Gross weight (kg)	Vol. (m ³)
63725	63652	8 LED	V	200mA	10	1950	1630	•	•	6,80	0,0293
63726	63653	8 LED	V	300mA	15	2800	2370	•	•	6,80	0,0293
63342	63276	16 LED	V	200mA	20	3900	3260	•	•	6,80	0,0293
63723	63650	16 LED	V	250mA	25	4650	3910	•	•	6,80	0,0293
63724	63651	16 LED	V	300mA	30	5550	4640	•	•	6,80	0,0293
63344	63277	16 LED	V	350mA	35	6400	5350	•	•	6,80	0,0293
63346	63310	24 LED	V	280mA	44	8200	6850	•	•	6,80	0,0293
63348	63278	24 LED	V	400mA	59	10550	8830	•	•	6,80	0,0293
63350	63312	24 LED	V	455mA	67	11950	9960	•	•	6,80	0,0293

Tecnologia LED MD

MD LED technology

63096	63097	8 LED	V	530mA	13	2200	1870	•	•	6,80	0,0293
63098	63099	8 LED	V	700mA	18	2900	2420	•	•	6,80	0,0293
63100	63101	16 LED	V	530mA	26	4500	3770	•	•	6,80	0,0293
63102	63103	16 LED	V	700mA	35	5750	4820	•	•	6,80	0,0293
63104	63105	24 LED	V	530mA	40	6800	5690	•	•	6,80	0,0293
63106	63107	24 LED	V	700mA	52	8500	7120	•	•	6,80	0,0293

Tecnologia LED Singlechip (2mmq)

Singlechip LED technology (2mmq)

63858	63940	16 LED	V	750mA	37	6200	5200	•	•	6,80	0,0293
63220	63221	16 LED	V	800mA	40	6600	5500	•	•	6,80	0,0293
63859	63941	16 LED	V	900mA	45	7300	6120	•	•	6,80	0,0293
63860	63942	24 LED	V	700mA	52	8700	7290	•	•	6,80	0,0293
63108	63109	24 LED	V	800mA	59	9850	8210	•	•	6,80	0,0293

Tecnologia LED Singlechip (4mmq)

Singlechip LED technology (4mmq)

I valori di flusso indicati devono essere considerati con una tolleranza del +/- 10%.
I valori di potenza elettrica indicati devono essere considerati con una tolleranza del +/- 7%.
I flussi luminosi indicati in tabella subiranno modifiche e miglioramenti in funzione della continua evoluzione tecnica dell'efficienza luminosa dei led.

*The flux values are to be considered with a tolerance of +/- 10%.
The wattages values are to be considered with a tolerance of +/- 7%.
The flows indicated in the table may be changed and improved according to the constant technical evolution of the light efficiency of the led.*

Accessori e ricambi / Accessories and spare parts



60031
Mensola a spigolo componibile
Modular corner bracket



60026
Mensola a parete elettrosaldata
Wall bracket electro welded



60030
Mensola a parete componibile
Modular wall bracket



60063
Mensola a spigolo elettrosaldata
Corner bracket electro welded

Codice Code	Descrizione Description	Peso Lordo Gross Weight (Kg)	Conf. Packing (Pz./Pcs)	Colore Color	Vol. (m ³)
60026	Mensola a parete elettrosaldata Ø mm 60 Wall bracket electro welded Ø mm 60	1,27	6	Zincata a caldo Hot galvanized	0,00257
60030	Mensola a parete componibile Ø mm 60 Modular wall bracket Ø mm 60	1,05	4	Zincata a caldo Hot galvanized	0,00160
60063	Mensola a spigolo elettrosaldata Ø mm 60 Corner bracket electro welded Ø mm 60	2,60	4	Zincata a caldo Hot galvanized	0,00835
60031	Mensola a spigolo componibile Ø mm 60 Modular corner bracket Ø mm 60	1,90	3	Zincata a caldo Hot galvanized	0,00210
18332	PROXIMO Vetro temperato extra chiaro 4 mm Extra-clear tempered glass 4 mm thick				
20643	PROXIMO CITY Vetro temperato extra chiaro 4 mm Extra-clear tempered glass 4 mm thick				
25786	PROXIMO WAY Vetro temperato extra chiaro 4 mm Extra-clear tempered glass 4 mm thick				

PROXIMO SERIES

Esercizi illuminotecnici / *Lighting exercises*



Categorie illuminotecniche stradali secondo la norma tecnica EN 13201-2
Street lighting categories, in accordance with the technical regulation EN 13201-2



PROXIMO - 24 LED MULTICHIP - OTTICA AB1 - 800mA
PROXIMO - 24 LED MULTICHIP - AB1 OPTIC - 800mA

Dati		Data	
Larghezza carreggiata:	2X12 metri	Carriageway width:	2X12 meters
Numero di corsie:	2X3	Number of lanes:	2X3
Altezza di installazione:	12 metri	Installation height:	12 meters
Interdistanza pali:	45 metri	Poles distance:	45 meters
Posizionamento pali:	affacciati	Poles positioning:	opposite
Fattore di manutenzione:	0,80	Maintenance factor:	0.80

Lav	U0	UI	fTI	EIR*	P (W)	Efficiency (lm/W)	IPEI	CATEGORY
2,12	0,62	0,72	10%	0,55	230	138	0,32	M1



PROXIMO CITY - 24 LED MD - OTTICA AB1 - 400mA
PROXIMO CITY - 24 LED MD - AB1 OPTIC - 400mA

Dati		Data	
Larghezza carreggiata:	2X7 metri	Carriageway width:	2X7 meters
Numero di corsie:	2X2	Number of lanes:	2X2
Altezza di installazione:	7,50 metri	Installation height:	7.50 meters
Interdistanza pali:	28 metri	Poles distance:	28 meters
Posizionamento pali:	doppio sbraccio mediana centrale	Poles positioning:	double arm pole median arrangement
Fattore di manutenzione:	0,80	Maintenance factor:	0.80

Lav	U0	UI	fTI	EIR*	P (W)	Efficiency (lm/W)	IPEI	CATEGORY
1,50	0,40	0,72	9%	0,42	57	150	0,30	M2



PROXIMO WAY - 24 LED MD - OTTICA V - 400mA
PROXIMO WAY - 24 LED MD - V OPTIC - 400mA

Dati		Data	
Larghezza carreggiata:	7 metri	Carriageway width:	7 meters
Numero di corsie:	2	Number of lanes:	2
Altezza di installazione:	8 metri	Installation height:	8 meters
Interdistanza pali:	36 metri	Poles distance:	36 meters
Posizionamento pali:	unilaterale	Poles positioning:	unilateral
Fattore di manutenzione:	0,80	Maintenance factor:	0.80

Lav	U0	UI	fTI	EIR*	P (W)	Efficiency (lm/W)	IPEI	CATEGORY
1,00	0,42	0,6	7%	0,37	59	146,77	0,36	M3

* EIR Edge Illumination Ratio secondo la norma EN 13201-2: 2015
 * EIR Edge Illumination Ratio in accordance with EN 13201-2: 2015