



Elevato contenuto estetico ed alta efficienza illuminotecnica caratterizzano la serie Challenge. Grazie al sistema di dissipazione interno all'apparecchio, questa serie di armature stradali, disponibile nelle tre differenti dimensioni Challenge, Challenge City e Challenge Way, offre all'illuminazione stradale un prodotto che coniuga compattezza, design e flessibilità di utilizzo.

Prodotto in base ai dettami dell'economia circolare, la serie CHALLENGE, certificato Zhaga-D4i, offre infinite soluzioni WISE per il controllo e la gestione del flusso luminoso.

High aesthetic content and high lighting efficiency characterize the Challenge series. Thanks to the inner heat removal system, this streetlighting series, available in three different sizes, Challenge, Challenge City and Challenge Way, offers a product that combines compactness, design and flexibility of use.

Manufactured according to the dictates of the circular economy, the CHALLENGE series, certified by Zhaga-D4i, offers endless WISE solutions for the control and management of the luminous flux.



MATERIALI E FINITURE



- Base portante e copertura in pressofusione di alluminio con titolo minimo EN 47100 a basso contenuto di rame ed alta resistenza agli agenti atmosferici.
- Copertura superiore a finitura liscia ad alto contenuto estetico, con sistema di asportazione del calore interno all'apparecchio.
- Verniciato con il processo AION, a polveri poliesteri di colore Silver (RAL 9006) resistente ai raggi UV secondo la norma ASTM D4587:2011 e alla nebbia salina secondo la norma EN ISO 9227:2017, con durata minima all'esposizione di 3000 ore.
- Coperchio posteriore per la chiusura del vano attacco palo in materiale plastico ad alta resistenza (solo per CHALLENGE).
- Filtro di compensazione pressoria in teflon.
- Guarnizioni in gomma antinvecchiamento, rimovibili.
- Schermo di protezione in vetro di sicurezza temperato extra chiaro 4 mm.
- Viteria esterna imperdibile in acciaio INOX.
- Molla di chiusura in acciaio INOX.

CARATTERISTICHE MECCANICHE

- Sostituzione dell'intero modulo LED completo della copertura dell'apparecchio.
- Apertura per l'accesso all'ottica e vano cablaggio in un'unica e semplice operazione agendo sulla molla in acciaio inox senza l'utilizzo di utensili.
- Per evitare la chiusura accidentale della copertura durante le fasi di montaggio e manutenzione, l'apparecchio è dotato di dispositivo automatico di blocco.

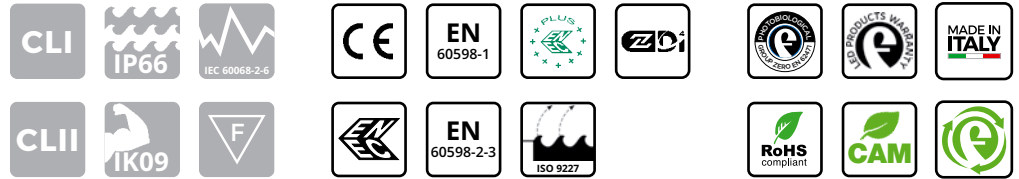

MATERIALS AND FINISHES



- Body and cover in die-cast aluminum with minimum EN 47100 title with low content copper and high resistance to atmospheric agents.
- Upper cover with smooth finish of highly aesthetic aspect and inner heat removal system.
- Coated with the AION process, in silver-colored polyester powders (RAL 9006) resistant to UV rays according to ASTM D4587:2011 standard and to salt spray according to EN ISO 9227:2017, with a duration of 3000 hours.
- Rear cover for closing the attachment compartment pole in high resistance plastic material (only for CHALLENGE).
- Pressure compensation filter in Teflon.
- Gaskets in anti-aging rubber, removable.
- Extra-clear tempered safety glass protection screen, 4mm thick.
- Stainless steel external captive screws.
- Stainless steel closure clip.

MECHANICAL CHARACTERISTICS

- Replacement of the entire LED module including the upper cover.
- Opening provides access to optics and cable box in a single, easy step by using the quick release clip in stainless steel, without using additional tools.
- To prevent accidental closure of the cover during assembly and maintenance, the device is equipped with an automatic anti-closing mechanism.

INSTALLAZIONE / INSTALLATION



Installazione a palo con sistema di attacco regolabile in alluminio pressofuso.
Adjust pole mounting system in die cast aluminium.

	CHALLENGE	CHALLENGE CITY	CHALLENGE WAY
Diametro palo Pole diameter	Ø 46 mm ÷ 76 mm	Ø 46 mm ÷ 76 mm	Ø 46 mm ÷ 60 mm
Installazione a testa palo Installation on straight pole	0°, +5°, +10°, +15°, +20°	da 0° a +20° con passo costante di 2,5° from 0° to +20° with constant pitch of 2.5°	
Installazione a sbraccio Side entry installation	Dispositivo di fissaggio a palo per portare a 0° il tilt dell'apparecchio in caso di installazione su bracci con tilt di 5°, 10°, 15° e 20°. Fixing device pole to bring the tilt luminaire at 0° in case of side entry installation with tilt of 5°, 10°, 15° and 20°		
Altezza di installazione Installation height	4 ÷ 30 m	4 ÷ 20 m	4 ÷ 16 m

DIMENSIONI / DIMENSIONS

CHALLENGE

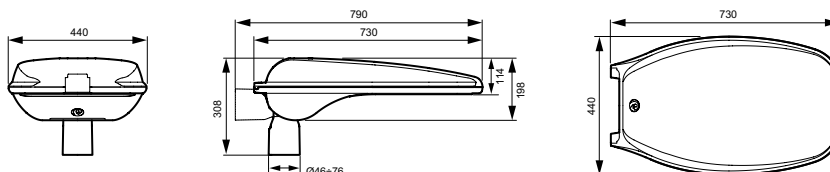

Peso max*
Max weight*

14,90 kg

Sup. esposta al vento con tilt 0°
Wind exposed surface with tilt 0°

laterale / lateral: 0,094 m²
frontale / front: 0,083 m²

CHALLENGE CITY

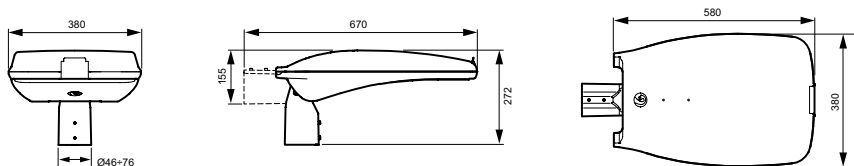

Peso max*
Max weight*

10 kg

Sup. esposta al vento con tilt 0°
Wind exposed surface with tilt 0°

laterale / lateral: 0,064 m²
frontale / front: 0,061 m²

CHALLENGE WAY

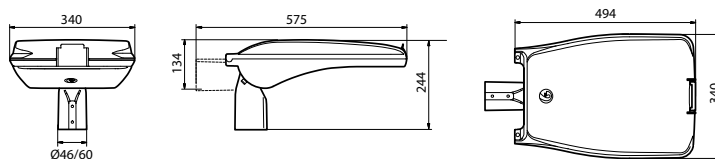

Peso max*
Max weight*

6 kg

Sup. esposta al vento con tilt 0°
Wind exposed surface with tilt 0°

laterale / lateral: 0,042 m²
frontale / front: 0,041 m²

* Tolleranza sul peso ± 5%
* Weight tolerance ± 5%

PROTEZIONE ALLE SOVRATENSIONI

- CL I: fino a 10kV sia di modo comune che differenziale.
- CL II: fino a 10kV di modo comune, 6kV di modo differenziale. A richiesta è possibile raggiungere 10kV anche in modo differenziale con SPD collegato tra fase e neutro.

CARATTERISTICHE DI ALIMENTAZIONE

- Gruppo di alimentazione costituito da driver programmabile con durata di vita maggiore di 100.000h.
- Alimentatore elettronico con protezione termica integrata ad elevata efficienza e durata progettato per uso esterno. Tutte le versioni sono protette contro le sovratensioni e le sovracorrenti per la protezione dei componenti e dei LED.
- Il sistema, sia in CL I che in CL II, è dotato di sezionatore per interrompere l'alimentazione all'apertura dell'apparecchio.
- Ingresso cavo attraverso pressacavo PG16 antistrappo, IP68.
- Fattore di correzione di potenza a pieno carico > 0.9.
- Alimentazione 220 - 240V / 50 - 60 Hz VAC.
- Piastra cablaggio completa di unità elettronica facilmente sostituibile.



WISE SOLUTIONS (OPTIONAL)

- Dimmerazione automatica tramite sistema di mezzanotte virtuale con profili programmati che soddisfano le richieste del cliente.
- Funzionalità CLO: programmazione dell'alimentazione in modo tale da aumentare gradualmente la corrente di pilotaggio dei led e compensarne il decadimento fisiologico.
- Orologio astronomico: funzionalità che permette l'accensione e lo spegnimento dell'impianto in funzione di determinate fasce orarie preimpostate.
- 1-10V: interfaccia di dimmerazione analogica mediante protocollo 1-10V.
- DALI: interfaccia di dimmerazione digitale mediante protocollo DALI.
- Regolazione del flusso luminoso tramite onde convogliate.
- Main voltage dimming: funzionalità che permette la variazione del flusso luminoso agendo sulla variazione della tensione di alimentazione fornita dal quadro di comando dell'impianto di illuminazione.
- NEMA: Presa 7 pin (ANSI C136.41).
- ZHAGA: Presa 4 pin (ZHAGA Book 18). Prodotto certificato Zhaga-D4i.

PROTECTION AGAINST SURGES

- CL I: up to 10kV both common and differential mode.
- CL II: up to 10 kV common mode, differential mode 6kV. On request it is possible to reach 10kV also in differential mode with SPD connected between phase and neutral.

POWER SUPPLY CHARACTERISTICS

- Power supply unit consisting of a programmable driver with a lifespan greater than 100,000h.
- Electronic power supply with integrated thermal protection with high efficiency and durability intended for external use. All versions are protected against overloads and surges to protect components and LEDs.
- The system, both in CL I and in CL II, is equipped with a knife switch to interrupt the power supply at the device's opening.
- The power supply cable accesses the device through a PG 16 cable gland (IP68).
- Power correction factor at full load > 0.9.
- Power supply 220 - 240V / 50 - 60 Hz VAC.
- Cable plate complete with easily replaceable electronic unit.



WISE SOLUTIONS (OPTIONAL)

- Automatic dimming through virtual midnight system with customized profiles according to specific needs.
- CLO functionality: the driver can be programmed to gradually increase the level of drive current fed to the LEDs in order to compensate their physiological lifespan reduction.
- Astronomical clock: this function the system to be switched on and off according to certain preset time slots.
- 1-10V: analog dimming interface via 1-10V protocol.
- DALI: digital dimming interface via DALI protocol.
- Adjustment of the luminous flux through conveyed waves.
- Main voltage dimming: this function allows the variation of the luminous flux by acting on the variation of the power supply voltage supplied by the control panel of the lighting system.
- NEMA SOCKET: 7 pins (ANSI C136.41).
- ZHAGA SOCKET: 4 pins (ZHAGA Book 18). Zhaga-D4i certified product.

- Sistema ottico stradale **SAFEWAY®** a rifrazione/riflessione e a rifrazione.
- Gruppo ottico facilmente sostituibile.
- Tecnologia LED Multi-die, Singlechip e Multichip su circuito stampato in alluminio altamente dissipante termicamente MCPCB (Metal Core Printed Circuit Board).
- Sistema di dissipazione del calore interno all'apparecchio.
- Temperatura colore sorgente LED: 4000K - CRI > 70. Gli apparecchi sono disponibili, su richiesta, anche con temperatura di colore compresa tra 2700 e 5700K.

CARATTERISTICHE SISTEMA OTTICO

OPTICAL SYSTEM CHARACTERISTICS

- **SAFEWAY®** optic system: refraction / reflection system and refraction system.
- Optic group easily replaceable.
- Multi-die, Singlechip e Multichip LED Technology on a pressed aluminum circuit, highly dissipating MCPCB (Metal Core Printed Circuit Board).
- Inner heat removal system.
- Color temperature: 4000K - CRI>70. The streetlights are available on request also with color temperatures between 2700 and 5700K.

SISTEMA OTTICO A RIFRAZIONE/RIFLESSIONE

REFRACTION/REFLECTION OPTIC SYSTEM



SISTEMA OTTICO A RIFRAZIONE

REFRACTION OPTIC SYSTEM



FLUSSO LUMINOSO MEDIO MANTENUTO SECONDO LA NORMA LM80 - TM21

MAINTAINED AVERAGE LUMINOUS FLUX ACCORDING TO LM80 - TM21 STANDARDS



Intervallo di temperatura di esercizio delle armature stradali*
Streetlights operating temperature range*

Ta 35°C	-40°C ÷ +40°C	L90B10	>100.000 hrs
---------	---------------	--------	--------------

Ta 55°C	-40°C ÷ +55°C	L80B10	>50.000 hrs
---------	---------------	--------	-------------

*Temperatura massima di esercizio dell'apparecchio in condizioni normali. Questa indicazione non esclude un funzionamento temporaneo dell'apparecchio alle temperature di esercizio indicate.

*Maximum operating temperature of the floodlights in normal conditions. This indication does not exclude temporary operation of the floodlights at the indicated operating temperatures.



Curve fotometriche / Photometric data

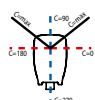
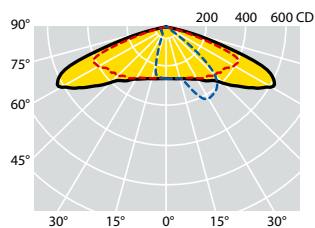

C max = 20°
LED 2mmq

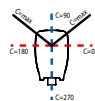
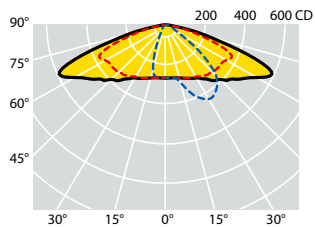
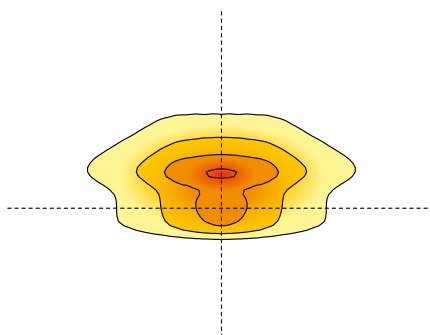

C max = 15°
LED 4x4mmq

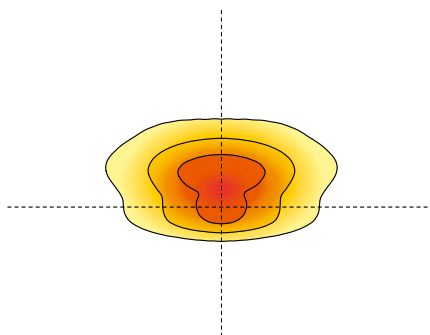

OTTICA AB1:

Ottica stradale normalmente impiegata per tutte le categorie illuminotecniche, specialmente quando il rapporto tra l'altezza di installazione dell'apparecchio e la larghezza della carreggiata è maggiore di 0,85. Risolve strade con rapporto tra l'interdistanza dei pali e l'altezza di installazione anche superiore a 4.

AB1 OPTIC:

Street optic normally used for all street illumination categories, especially when the relation between the installation height and the carriage width is greater than 0.85. This optic solves roads with a relationship between the poles distance and the installation height even higher than 4.

Codici prodotto / *Product codes*

4000K - CRI > 70

Codice Code CL I	Codice Code CL II	Numero LED Number of LED	Ottica Optic	Corrente di pilotaggio Led Current (mA)	W (LED+ DRIVER)	Flusso lum. nom. piastra LED Nominal flux LED plate (Lumen)	Flusso utile in uscita Useful output flux (Lumen)	Temp. ambiente Ambient temp. ta 35°C ta 55°C		Peso lordo Gross weight (kg)	Vol. (m ³)
43501	43701	49 LED	AB1	530mA	81	14450	12080	•	•	16,60	0,0772
43502	43702	49 LED	AB1	700mA	106	17850	14900	•	•	16,60	0,0772
43503	43703	56 LED	AB1	530mA	90	16100	13450	•	•	16,60	0,0772
43504	43704	56 LED	AB1	700mA	120	19900	16610	•	•	16,60	0,0772
43505	43705	63 LED	AB1	530mA	105	18050	15070	•	•	16,60	0,0772
43506	43706	63 LED	AB1	700mA	135	22300	18600	•	•	16,60	0,0772
43507	43707	70 LED	AB1	530mA	117	19900	16600	•	•	16,60	0,0772
43508	43708	70 LED	AB1	700mA	148	24050	20080	•	•	16,60	0,0772
43509	43709	77 LED	AB1	530mA	125	21500	17930	•	•	16,60	0,0772
43510	43710	77 LED	AB1	700mA	166	26750	22330	•	•	16,60	0,0772
43513	43713	84 LED	AB1	530mA	135	23350	19470	•	•	16,60	0,0772
43514	43714	84 LED	AB1	700mA	182	29100	24260	•	•	16,60	0,0772

Tecnologia LED Singlechip (2mmq)

Singlechip LED technology (2mmq)

43541	43846	20 LED	AB1	700mA	168	29100	24270	•	•	16,80	0,0772
43204	43205	20 LED	AB1	800mA	192	33100	27590	•	•	16,80	0,0772
43542	43847	20 LED	AB1	900mA	216	35200	29370	•	•	16,80	0,0772
43206	43207	20 LED	AB1	1000mA	240	38900	32430	•	•	16,80	0,0772
43208	43209	24 LED	AB1	800mA	230	38900	32430	•	•	16,80	0,0772
43543	43848	24 LED	AB1	900mA	259	41350	34470	•	•	16,80	0,0772
43210	43211	24 LED	AB1	1000mA	288	45800	38180	•	•	16,80	0,0772
43956	43957	28 LED	AB1	700mA	235	38550	32130	•	•	17,20	0,0772
43212	43213	28 LED	AB1	800mA	268	43900	36610	•	•	17,20	0,0772
43214	43215	28 LED	AB1	900mA	301	47100	39270	•	•	17,20	0,0772

Tecnologia LED Multichip (4X4mmq)

Multichip LED technology (4X4mmq)

I valori di flusso indicati devono essere considerati con una tolleranza del +/- 10%.
I valori di potenza elettrica indicati devono essere considerati con una tolleranza del +/- 7%.
I flussi luminosi indicati in tabella subiranno modifiche e miglioramenti in funzione della continua evoluzione tecnica dell'efficienza luminosa dei led.

*The flux values are to be considered with a tolerance of +/- 10%.
The wattages values are to be considered with a tolerance of +/- 7%.
The flows indicated in the table may be changed and improved according to the constant technical evolution of the light efficiency of the led.*



Curve fotometriche / Photometric data

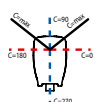
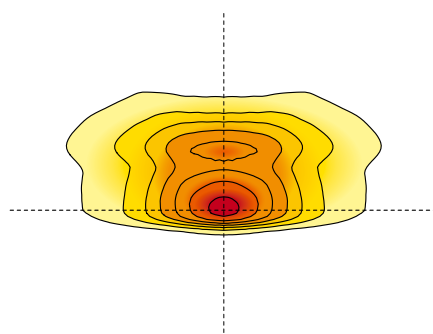
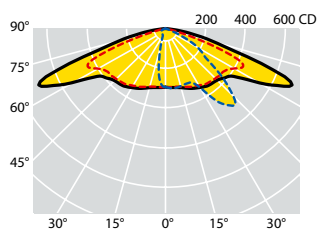

C max = 30°
LED 2mmq

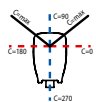
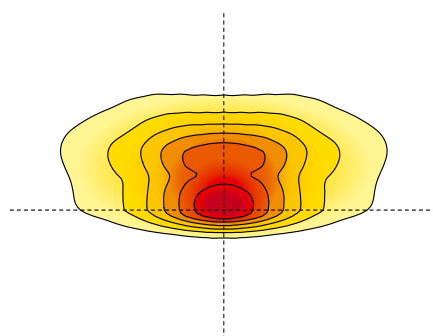
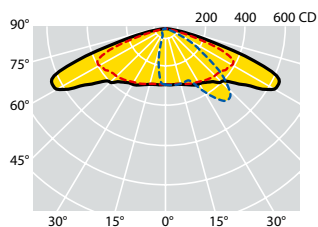

C max = 25°
LED 4x4mmq

OTTICA L10:

Ottica stradale normalmente impiegata per tutte le categorie illuminotecniche, specialmente quando il rapporto tra l'altezza di installazione dell'apparecchio e la larghezza della carreggiata è notevolmente maggiore di 1. Grazie al sistema ottico brevettato Safeway, che sfrutta la possibilità di inclinare i riflettori con angoli diversi, tale ottica permette di illuminare aree frontali molto ampie, risolvendo larghe carreggiate, strade a più corsie, parcheggi e piazzali molto profondi.

L10 OPTIC:

Street optic normally used for all categories lighting, especially when the installation height and the carriage width ratio is considerably greater than 1. Thanks to the Safeway patented optical system, which uses the possibility of tilting the reflectors with different inclinations, with this optic is possible to light wide frontal areas, resolving broad carriageways, roads with multiple lanes, parking spaces and very deep squares.

Codici prodotto / *Product codes*

4000K - CRI > 70

Codice Code CL I	Codice Code CL II	Numero LED Number of LED	Ottica Optic	Corrente di pilotaggio Led Current (mA)	W (LED+ DRIVER)	Flusso lum. nom. piastra LED Nominal flux LED plate (Lumen)	Flusso utile in uscita Useful output flux (Lumen)	Temp. ambiente Ambient temp. ta 35°C ta 55°C		Peso lordo Gross weight (kg)	Vol. (m ³)
43572	43877	49 LED	L10	530mA	81	14450	11710	•	•	16,60	0,0772
43573	43878	49 LED	L10	700mA	106	17850	14450	•	•	16,60	0,0772
43574	43879	56 LED	L10	530mA	90	16100	13040	•	•	16,60	0,0772
43575	43880	56 LED	L10	700mA	120	19900	16110	•	•	16,60	0,0772
43576	43881	63 LED	L10	530mA	105	18050	14610	•	•	16,60	0,0772
43577	43882	63 LED	L10	700mA	135	22300	18040	•	•	16,60	0,0772
43578	43883	70 LED	L10	530mA	117	19900	16100	•	•	16,60	0,0772
43579	43884	70 LED	L10	700mA	148	24050	19470	•	•	16,60	0,0772
43580	43885	77 LED	L10	530mA	125	21500	17390	•	•	16,60	0,0772
43581	43886	77 LED	L10	700mA	166	26750	21660	•	•	16,60	0,0772
43582	43887	84 LED	L10	530mA	135	23350	18880	•	•	16,60	0,0772
43583	43888	84 LED	L10	700mA	182	29100	23530	•	•	16,60	0,0772
Tecnologia LED Singlechip (2mmq)						<i>Singlechip LED technology (2mmq)</i>					
43584	43889	20 LED	L10	700mA	168	29100	23540	•	•	16,80	0,0772
43585	43890	20 LED	L10	800mA	192	33100	26750	•	•	16,80	0,0772
43586	43891	20 LED	L10	900mA	216	35200	28480	•	•	16,80	0,0772
43587	43892	20 LED	L10	1000mA	240	38900	31450	•	•	16,80	0,0772
43588	43893	24 LED	L10	800mA	230	38900	31450	•	•	16,80	0,0772
43589	43894	24 LED	L10	900mA	259	41350	33430	•	•	16,80	0,0772
43590	43895	24 LED	L10	1000mA	288	45800	37030	•	•	16,80	0,0772
43591	43896	28 LED	L10	700mA	235	38550	31160	•	•	17,20	0,0772
43592	43897	28 LED	L10	800mA	268	43900	35510	•	•	17,20	0,0772
43593	43898	28 LED	L10	900mA	301	47100	38080	•	•	17,20	0,0772
Tecnologia LED Multichip (4X4mmq)						<i>Multichip LED technology (4X4mmq)</i>					

I valori di flusso indicati devono essere considerati con una tolleranza del +/- 10%.
I valori di potenza elettrica indicati devono essere considerati con una tolleranza del +/- 7%.
I flussi luminosi indicati in tabella subiranno modifiche e miglioramenti in funzione della continua evoluzione tecnica dell'efficienza luminosa dei led.

*The flux values are to be considered with a tolerance of +/- 10%.
The wattages values are to be considered with a tolerance of +/- 7%.
The flows indicated in the table may be changed and improved according to the constant technical evolution of the light efficiency of the led.*



Curve fotometriche / Photometric data

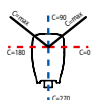
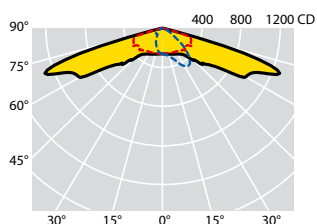

C max = 25°
LED 2mmq

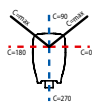
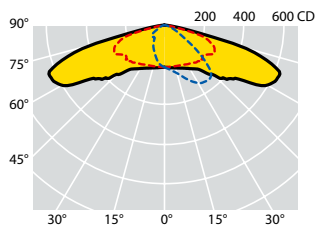
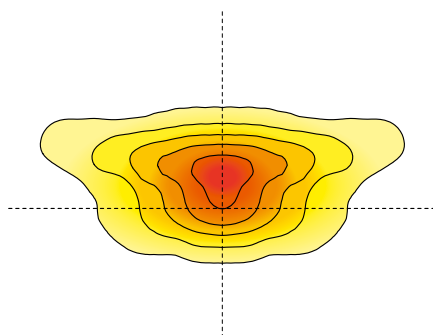

C max = 20°
LED 4mmq

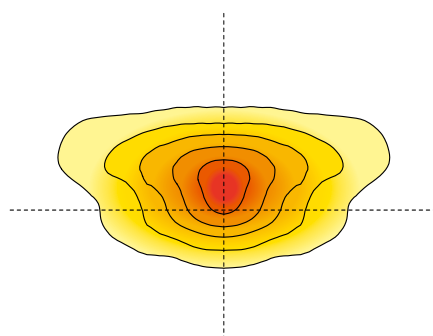

OTTICA W2:

Ottica stradale normalmente impiegata per tutte le categorie illuminotecniche, specialmente quando il rapporto tra l'altezza di installazione dell'apparecchio e la larghezza della carreggiata è maggiore di 0,85. L'ottica W2, presenta un notevole retroflusso che permette di risolvere installazioni con sbracci.

W2 OPTIC:

Street optic normally used for all categories lighting, especially when the installation height and the carriage width ratio is considerably greater than 0.85. The W2 optic features a notable back-flow that allows to solve installations with outreaches.

Codici prodotto / *Product codes*

4000K - CRI > 70

Codice Code CL I	Codice Code CL II	Numero LED Number of LED	Ottica Optic	Corrente di pilotaggio Led Current (mA)	W (LED+ DRIVER)	Flusso lum. nom. piastra LED Nominal flux LED plate (Lumen)	Flusso utile in uscita Useful output flux (Lumen)	Temp. ambiente Ambient temp. ta 35°C ta 55°C		Peso lordo Gross weight (kg)	Vol. (m ³)
43672	43931	64 LED	W2	530mA	107	18700	15600	•	•	16,60	0,0772
43673	43932	64 LED	W2	600mA	121	20500	17100	•		16,60	0,0772
43674	43933	64 LED	W2	700mA	137	23050	19240	•		16,60	0,0772
43675	43934	80 LED	W2	530mA	129	22850	19050	•	•	16,60	0,0772
43676	43935	80 LED	W2	600mA	146	24800	20700	•		16,60	0,0772
43677	43936	80 LED	W2	700mA	174	28400	23670	•		16,60	0,0772
Tecnologia LED Singlechip (2mmq)						<i>Singlechip LED technology (2mmq)</i>					
43678	43937	64 LED	W2	800mA	159	28400	23690	•		16,60	0,0772
43679	43938	64 LED	W2	900mA	181	31050	25900	•		16,60	0,0772
43680	43939	64 LED	W2	1000mA	203	34200	28500	•		16,60	0,0772
43681	43940	80 LED	W2	800mA	198	35050	29210	•		16,60	0,0772
43682	43941	80 LED	W2	900mA	225	37650	31410	•		16,60	0,0772
43683	43942	80 LED	W2	1000mA	252	41500	34620	•		16,60	0,0772
Tecnologia LED Singlechip (4mmq)						<i>Singlechip LED technology (4mmq)</i>					

I valori di flusso indicati devono essere considerati con una tolleranza del +/- 10%.
I valori di potenza elettrica indicati devono essere considerati con una tolleranza del +/- 7%.
I flussi luminosi indicati in tabella subiranno modifiche e miglioramenti in funzione della continua evoluzione tecnica dell'efficienza luminosa dei led.

*The flux values are to be considered with a tolerance of +/- 10%.
The wattages values are to be considered with a tolerance of +/- 7%.
The flows indicated in the table may be changed and improved according to the constant technical evolution of the light efficiency of the led.*



Curve fotometriche / Photometric data

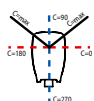
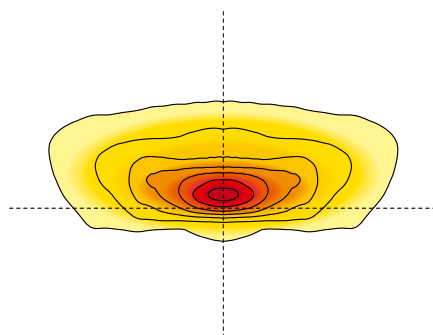
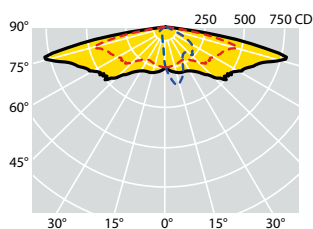

C max = 20°
LED 2mmq

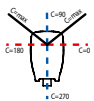
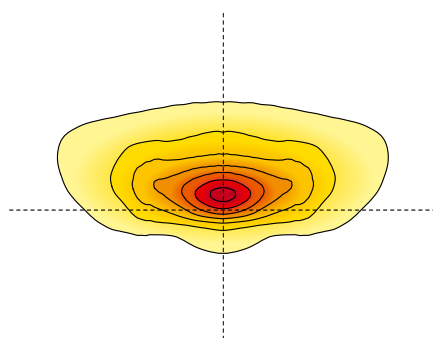
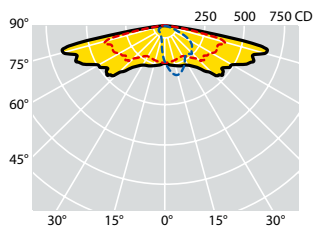

C max = 15°
LED 4mmq

OTTICA S:

Ottica stradale normalmente impiegata per categorie illuminotecniche fino a M3. Tale ottica è particolarmente indicata in situazioni in cui il rapporto tra l'altezza di installazione e la larghezza della carreggiata è inferiore a 1. Risolve strade con interdistanze molto elevate e rapporto interdistanza / altezza d'installazione superiore a 5.

S OPTIC:

Street optic normally used for lighting categories up to M3. This optic is particularly suitable for situations where the installation height and the width of the carriageway ratio is less than 1. It is also appropriate for roads with very high interdistances and an interdistance / installation height ratio greater than 5.

Codici prodotto / *Product codes*

4000K - CRI > 70

Codice Code CL I	Codice Code CL II	Numero LED Number of LED	Ottica Optic	Corrente di pilotaggio Led Current (mA)	W (LED+ DRIVER)	Flusso lum. nom. piastra LED Nominal flux LED plate (Lumen)	Flusso utile in uscita Useful output flux (Lumen)	Temp. ambiente Ambient temp. ta 35°C ta 55°C		Peso lordo Gross weight (kg)	Vol. (m ³)
43430	43431	64 LED	S	530mA	107	18700	14660	•	•	16,60	0,0772
43668	43927	64 LED	S	600mA	121	20500	16070	•		16,60	0,0772
43432	43433	64 LED	S	700mA	137	23050	18080	•		16,60	0,0772
43434	43435	80 LED	S	530mA	129	22850	17900	•	•	16,60	0,0772
43669	43928	80 LED	S	600mA	146	24800	19450	•		16,60	0,0772
43436	43437	80 LED	S	700mA	174	28400	22240	•		16,60	0,0772
Tecnologia LED Singlechip (2mmq)						<i>Singlechip LED technology (2mmq)</i>					
43440	43441	64 LED	S	800mA	159	28400	22260	•		16,60	0,0772
43670	43929	64 LED	S	900mA	181	31050	24340	•		16,60	0,0772
43442	43443	64 LED	S	1000mA	203	34200	26790	•		16,60	0,0772
43671	43930	80 LED	S	800mA	198	35050	27450	•		16,60	0,0772
43444	43445	80 LED	S	900mA	225	37650	29520	•		16,60	0,0772
43446	43447	80 LED	S	1000mA	252	41500	32540	•		16,60	0,0772
Tecnologia LED Singlechip (4mmq)						<i>Singlechip LED technology (4mmq)</i>					

I valori di flusso indicati devono essere considerati con una tolleranza del +/- 10%.
I valori di potenza elettrica indicati devono essere considerati con una tolleranza del +/- 7%.
I flussi luminosi indicati in tabella subiranno modifiche e miglioramenti in funzione della continua evoluzione tecnica dell'efficienza luminosa dei led.

*The flux values are to be considered with a tolerance of +/- 10%.
The wattages values are to be considered with a tolerance of +/- 7%.
The flows indicated in the table may be changed and improved according to the constant technical evolution of the light efficiency of the led.*



Curve fotometriche / Photometric data

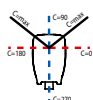
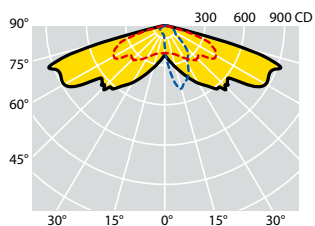

C max = 15°
LED 2mmq

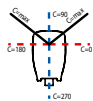
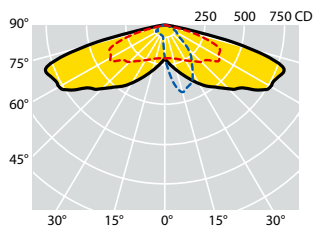
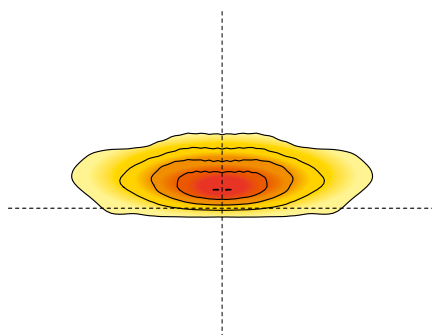

C max = 15°
LED 4mmq

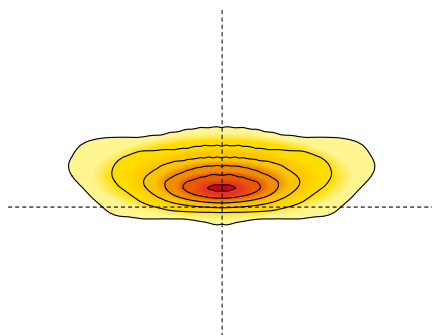

OTTICA V:

Ottica stradale particolarmente indicata in situazioni in cui il rapporto tra l'altezza di installazione e la larghezza della carreggiata è inferiore a 1.

VOPTIC:

Street optic particularly suitable for situations where the installation height and the width of the carriageway ratio is less than 1.

Codici prodotto / *Product codes*

4000K - CRI > 70

Codice Code CL I	Codice Code CL II	Numero LED Number of LED	Ottica Optic	Corrente di pilotaggio Led Current (mA)	W (LED+ DRIVER)	Flusso lum. nom. piastra LED Nominal flux LED plate (Lumen)	Flusso utile in uscita Useful output flux (Lumen)	Temp. ambiente Ambient temp. ta 35°C ta 55°C		Peso lordo Gross weight (kg)	Vol. (m ³)
43450	43451	64 LED	V	530mA	107	18700	15600	•	•	16,60	0,0772
43664	43923	64 LED	V	600mA	121	20500	17100	•		16,60	0,0772
43452	43453	64 LED	V	700mA	137	23050	19240	•		16,60	0,0772
43454	43455	80 LED	V	530mA	129	22850	19050	•	•	16,60	0,0772
43663	43924	80 LED	V	600mA	146	24800	20700	•		16,60	0,0772
43456	43457	80 LED	V	700mA	174	28400	23670	•		16,60	0,0772
Tecnologia LED Singlechip (2mmq)						<i>Singlechip LED technology (2mmq)</i>					
43460	43461	64 LED	V	800mA	159	28400	23690	•		16,60	0,0772
43666	43925	64 LED	V	900mA	181	31050	25900	•		16,60	0,0772
43462	43463	64 LED	V	1000mA	203	34200	28500	•		16,60	0,0772
43464	43465	80 LED	V	800mA	198	35050	29210	•		16,60	0,0772
43667	43926	80 LED	V	900mA	225	37650	31410	•		16,60	0,0772
43466	43467	80 LED	V	1000mA	252	41500	34620	•		16,60	0,0772
Tecnologia LED Singlechip (4mmq)						<i>Singlechip LED technology (4mmq)</i>					

I valori di flusso indicati devono essere considerati con una tolleranza del +/- 10%.
 I valori di potenza elettrica indicati devono essere considerati con una tolleranza del +/- 7%.
 I flussi luminosi indicati in tabella subiranno modifiche e miglioramenti in funzione della continua evoluzione tecnica dell'efficienza luminosa dei led.

*The flux values are to be considered with a tolerance of +/- 10%.
 The wattages values are to be considered with a tolerance of +/- 7%.
 The flows indicated in the table may be changed and improved according to the constant technical evolution of the light efficiency of the led.*



Curve fotometriche / Photometric data

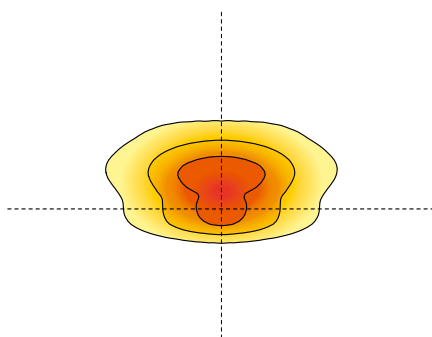
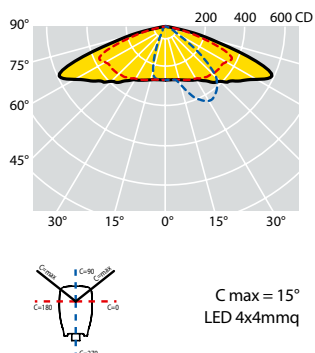
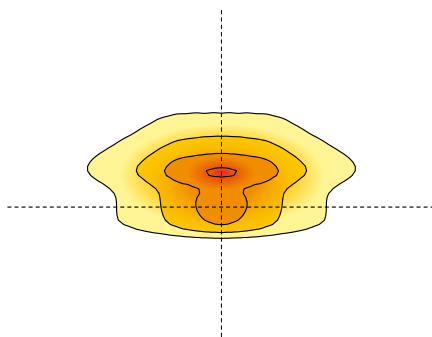
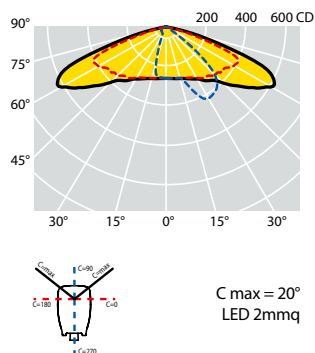
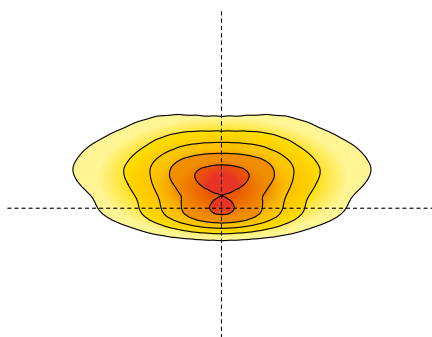
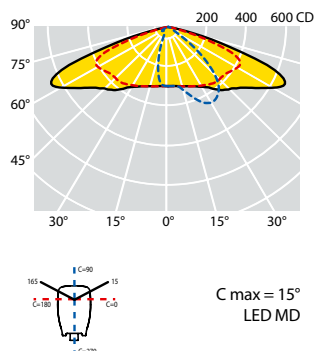

OTTICA AB1:

Ottica stradale normalmente impiegata per tutte le categorie illuminotecniche, specialmente quando il rapporto tra l'altezza di installazione dell'apparecchio e la larghezza della carreggiata è maggiore di 0,85. Risolve strade con rapporto tra l'interdistanza dei pali e l'altezza di installazione anche superiore a 4.

AB1 OPTIC:

Street optic normally used for all street illumination categories, especially when the relation between the installation height and the carriage width is greater than 0.85. This optic solves roads with a relationship between the poles distance and the installation height even higher than 4.

Codici prodotto / Product codes

4000K - CRI > 70

Codice Code CL I	Codice Code CL II	Numero LED Number of LED	Ottica Optic	Corrente di pilotaggio Led Current (mA)	W (LED+ DRIVER)	Flusso lum. nom. piastra LED Nominal flux LED plate (Lumen)	Flusso utile in uscita Useful output flux (Lumen)	Temp. ambiente Ambient temp. ta 35°C ta 55°C	Peso lordo Gross weight (kg)	Vol. (m ³)
45620	45592	24 LED	AB1	350mA	50	9300	7750	•	10,00	0,0514
47449	47403	24 LED	AB1	400mA	57	10450	8720	•	10,00	0,0514
45621	45615	30 LED	AB1	350mA	63	11700	9790	•	10,00	0,0514
45622	45593	30 LED	AB1	400mA	73	13000	10870	•	10,00	0,0514
45623	45594	36 LED	AB1	350mA	75	13800	11520	•	10,00	0,0514
47450	47404	36 LED	AB1	430mA	91	16100	13430	•	10,00	0,0514
45627	45603	36 LED	AB1	500mA	106	18150	15130	•	10,00	0,0514
Tecnologia LED MD						<i>MDLED technology</i>				
45033	45533	18 LED	AB1	530mA	29	4950	4150	• •	10,60	0,0514
45034	45534	18 LED	AB1	700mA	39	6350	5330	•	10,60	0,0514
68404	47870	24 LED	AB1	600mA	44	7250	6070	•	10,85	0,0514
45050	45550	24 LED	AB1	700mA	52	8450	7080	•	10,85	0,0514
Tecnologia LED Singlechip (2mmq)						<i>Singlechip LED technology (2mmq)</i>				
47220	47871	6 LED	AB1	600mA	44	8150	6830	• •	10,45	0,0514
47221	47872	6 LED	AB1	700mA	52	9400	7850	• •	10,45	0,0514
45435	45935	6 LED	AB1	800mA	58	10400	8670	• •	10,45	0,0514
47223	47873	6 LED	AB1	900mA	66	11350	9480	•	10,45	0,0514
45436	45936	6 LED	AB1	1000mA	73	12400	10340	•	10,45	0,0514
45467	45967	9 LED	AB1	800mA	85	15400	12850	• •	10,50	0,0514
47224	47874	9 LED	AB1	900mA	98	16600	13870	•	10,50	0,0514
45468	45968	9 LED	AB1	1000mA	109	18200	15190	•	10,50	0,0514
45477	45983	12 LED	AB1	700mA	99	17950	14990	• •	10,60	0,0514
47225	47875	12 LED	AB1	800mA	115	19300	16110	•	10,60	0,0514
47226	47876	12 LED	AB1	900mA	130	21250	17740	•	10,60	0,0514
45478	45984	12 LED	AB1	1000mA	144	23400	19510	•	10,60	0,0514
45419	45919	16 LED	AB1	700mA	130	21700	18100	• •	10,75	0,0514
45420	45920	16 LED	AB1	800mA	150	26150	21820	•	10,75	0,0514
Tecnologia LED Multichip (4X4mmq)						<i>Multichip LED technology (4X4mmq)</i>				

I valori di flusso indicati devono essere considerati con una tolleranza del +/- 10%.
I valori di potenza elettrica indicati devono essere considerati con una tolleranza del +/- 7%.
I flussi luminosi indicati in tabella subiranno modifiche e miglioramenti in funzione della continua evoluzione tecnica dell'efficienza luminosa dei led.

*The flux values are to be considered with a tolerance of +/- 10%.
The wattages values are to be considered with a tolerance of +/- 7%.
The flows indicated in the table may be changed and improved according to the constant technical evolution of the light efficiency of the led.*



Curve fotometriche / Photometric data

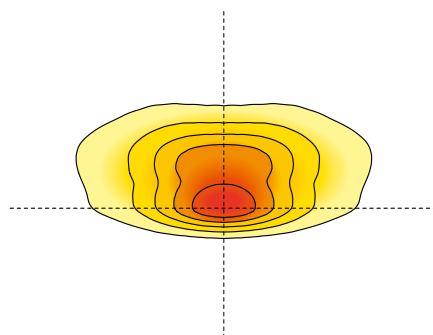
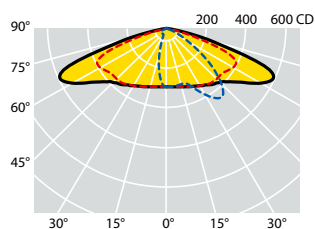

C max = 20°
LED MD

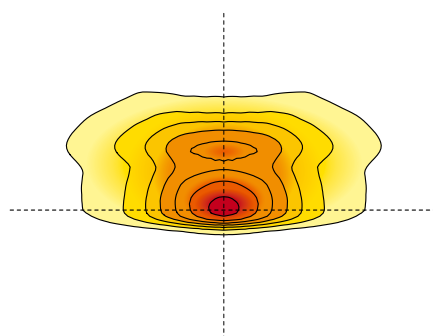
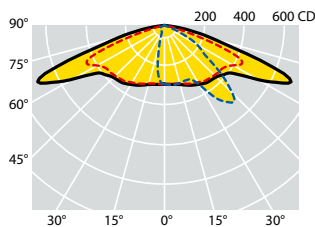

C max = 30°
LED 2mmq

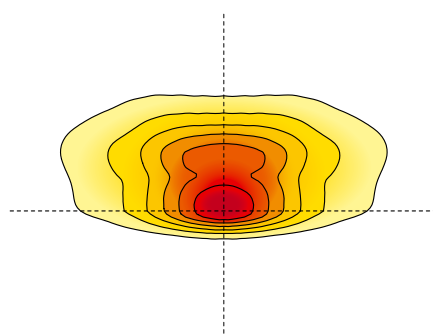
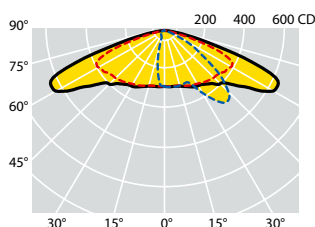

C max = 25°
LED 4x4mmq

OTTICA L10:

Ottica stradale normalmente impiegata per tutte le categorie illuminotecniche, specialmente quando il rapporto tra l'altezza di installazione dell'apparecchio e la larghezza della carreggiata è notevolmente maggiore di 1. Grazie al sistema ottico brevettato Safeway, che sfrutta la possibilità di inclinare i riflettori con angoli diversi, tale ottica permette di illuminare aree frontali molto ampie, risolvendo larghe carreggiate, strade a più corsie, parcheggi e piazzali molto profondi.

L10 OPTIC:

Street optic normally used for all categories lighting, especially when the installation height and the carriage width ratio is considerably greater than 1. Thanks to the Safeway patented optical system, which uses the possibility of tilting the reflectors with different inclinations, with this optic is possible to light wide frontal areas, resolving broad carriageways, roads with multiple lanes, parking spaces and very deep squares.

Codici prodotto / *Product codes*

4000K - CRI > 70

Codice Code CL I	Codice Code CL II	Numero LED Number of LED	Ottica Optic	Corrente di pilotaggio Led Current (mA)	W (LED+ DRIVER)	Flusso lum. nom. piastra LED Nominal flux LED plate (Lumen)	Flusso utile in uscita Useful output flux (Lumen)	Temp. ambiente Ambient temp. ta 35°C ta 55°C		Peso lordo Gross weight (kg)	Vol. (m ³)
47458	47412	24 LED	L10	350mA	50	9300	7580	•		10,00	0,0514
47463	47417	24 LED	L10	400mA	57	10450	8530	•		10,00	0,0514
47459	47413	30 LED	L10	350mA	63	11700	9580	•		10,00	0,0514
47460	47414	30 LED	L10	400mA	73	13000	10640	•		10,00	0,0514
47461	47415	36 LED	L10	350mA	75	13800	11290	•		10,00	0,0514
47464	47418	36 LED	L10	430mA	91	16100	13150	•		10,00	0,0514
47462	47416	36 LED	L10	500mA	106	18150	14830	•		10,00	0,0514
Tecnologia LED MD						<i>MDLED technology</i>					
47363	47905	18 LED	L10	530mA	29	4950	4020	•	•	10,60	0,0514
47364	47906	18 LED	L10	700mA	39	6350	5170	•		10,60	0,0514
47365	47907	24 LED	L10	600mA	44	7250	5880	•		10,85	0,0514
47366	47908	24 LED	L10	700mA	52	8450	6860	•		10,85	0,0514
Tecnologia LED Singlechip (2mmq)						<i>Singlechip LED technology (2mmq)</i>					
47367	47909	6 LED	L10	600mA	44	8150	6610	•	•	10,45	0,0514
47368	47910	6 LED	L10	700mA	52	9400	7600	•	•	10,45	0,0514
47369	47911	6 LED	L10	800mA	58	10400	8400	•	•	10,45	0,0514
47370	47912	6 LED	L10	900mA	66	11350	9200	•		10,45	0,0514
47371	47913	6 LED	L10	1000mA	73	12400	10020	•		10,45	0,0514
47372	47914	9 LED	L10	800mA	85	15400	12460	•	•	10,50	0,0514
47373	47915	9 LED	L10	900mA	98	16600	13450	•		10,50	0,0514
47374	47916	9 LED	L10	1000mA	109	18200	14730	•		10,50	0,0514
47375	47917	12 LED	L10	700mA	99	17950	14530	•	•	10,60	0,0514
47376	47918	12 LED	L10	800mA	115	19300	15620	•		10,60	0,0514
47377	47919	12 LED	L10	900mA	130	21250	17200	•		10,60	0,0514
47378	47920	12 LED	L10	1000mA	144	23400	18920	•		10,60	0,0514
47379	47921	16 LED	L10	700mA	130	21700	17550	•	•	10,75	0,0514
47380	47922	16 LED	L10	800mA	150	26150	21160	•		10,75	0,0514
Tecnologia LED Multichip (4X4mmq)						<i>Multichip LED technology (4X4mmq)</i>					

I valori di flusso indicati devono essere considerati con una tolleranza del +/- 10%.
I valori di potenza elettrica indicati devono essere considerati con una tolleranza del +/- 7%.
I flussi luminosi indicati in tabella subiranno modifiche e miglioramenti in funzione della continua evoluzione tecnica dell'efficienza luminosa dei led.

*The flux values are to be considered with a tolerance of +/- 10%.
The wattages values are to be considered with a tolerance of +/- 7%.
The flows indicated in the table may be changed and improved according to the constant technical evolution of the light efficiency of the led.*



Curve fotometriche / Photometric data

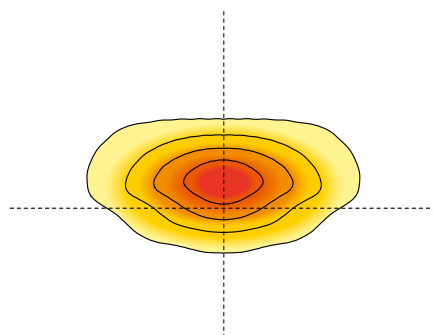
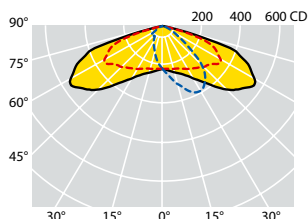

C max = 15°
LED MD

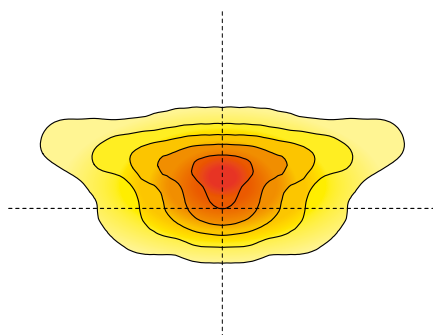
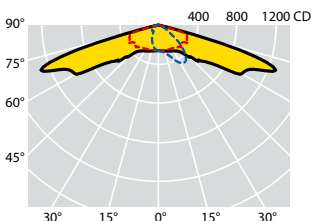

C max = 25°
LED 2mmq

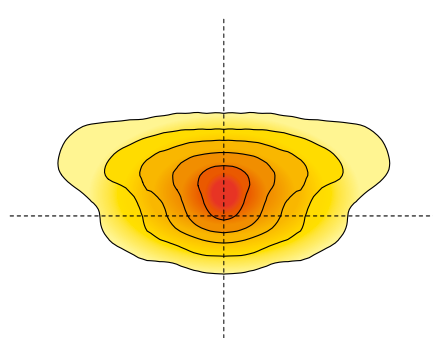
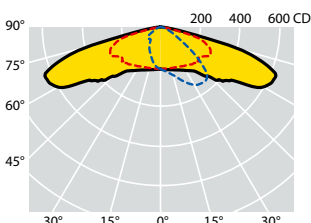

C max = 20°
LED 4mmq

OTTICA W2:

Ottica stradale normalmente impiegata per tutte le categorie illuminotecniche, specialmente quando il rapporto tra l'altezza di installazione dell'apparecchio e la larghezza della carreggiata è maggiore di 0,85. L'ottica W2, presenta un notevole retroflusso che permette di risolvere installazioni con sbracci.

W2 OPTIC:

Street optic normally used for all categories lighting, especially when the installation height and the carriage width ratio is considerably greater than 0.85. The W2 optic features a notable back-flow that allows to solve installations with outreaches.

Codici prodotto / *Product codes*

4000K - CRI > 70

Codice Code CL I	Codice Code CL II	Numero LED Number of LED	Ottica Optic	Corrente di pilotaggio Led Current (mA)	W (LED+ DRIVER)	Flusso lum. nom. piastra LED Nominal flux LED plate (Lumen)	Flusso utile in uscita Useful output flux (Lumen)	Temp. ambiente Ambient temp. ta 35°C ta 55°C		Peso lordo Gross weight (kg)	Vol. (m ³)
47479	47433	36 LED	W2	200mA	43	8550	7140	•	•	10,00	0,0514
47480	47434	36 LED	W2	230mA	49	9650	8050	•	•	10,00	0,0514
47481	47435	36 LED	W2	280mA	60	11450	9580	•	•	10,00	0,0514
47482	47436	36 LED	W2	350mA	75	13850	11570	•	•	10,00	0,0514
47483	47437	36 LED	W2	480mA	103	17450	14580	•	•	10,00	0,0514
47484	47438	48 LED	W2	200mA	56	10900	9120	•	•	10,00	0,0514
47485	47439	48 LED	W2	350mA	100	18450	15400	•	•	10,00	0,0514
47486	47440	48 LED	W2	400mA	114	20450	17080	•	•	10,00	0,0514

Tecnologia LED MD

MDLED technology

47852	47949	24 LED	W2	530mA	40	6800	5700	•	•	10,00	0,0514
47853	68403	24 LED	W2	700mA	52	8600	7200	•	•	10,00	0,0514
47854	47951	36 LED	W2	530mA	58	9900	8250	•	•	10,10	0,0514
47855	47952	36 LED	W2	600mA	67	11000	9200	•	•	10,10	0,0514
47856	47953	36 LED	W2	700mA	76	12500	10450	•	•	10,10	0,0514

Tecnologia LED Singlechip (2mmq)

Singlechip LED technology (2mmq)

47857	47954	36 LED	W2	700mA	76	12950	10810	•	•	10,10	0,0514
47858	47955	36 LED	W2	800mA	88	14900	12440	•	•	10,10	0,0514
47859	47956	36 LED	W2	900mA	101	16800	14020	•	•	10,10	0,0514
47860	47957	36 LED	W2	1000mA	115	17900	14940	•	•	10,10	0,0514

Tecnologia LED Singlechip (4mmq)

Singlechip LED technology (4mmq)

I valori di flusso indicati devono essere considerati con una tolleranza del +/- 10%.
I valori di potenza elettrica indicati devono essere considerati con una tolleranza del +/- 7%.
I flussi luminosi indicati in tabella subiranno modifiche e miglioramenti in funzione della continua evoluzione tecnica dell'efficienza luminosa dei led.

*The flux values are to be considered with a tolerance of +/- 10%.
The wattages values are to be considered with a tolerance of +/- 7%.
The flows indicated in the table may be changed and improved according to the constant technical evolution of the light efficiency of the led.*



Curve fotometriche / Photometric data

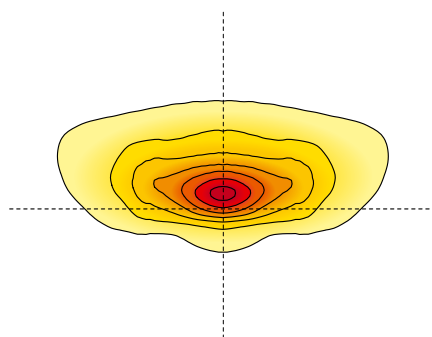
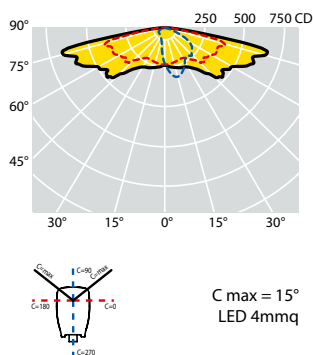
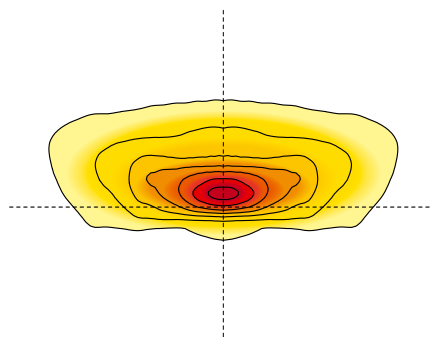
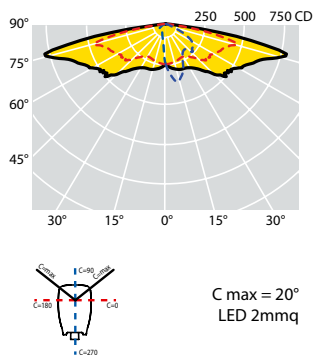
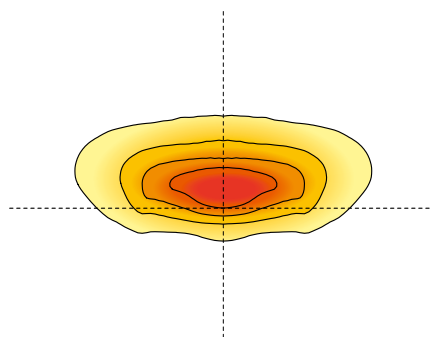
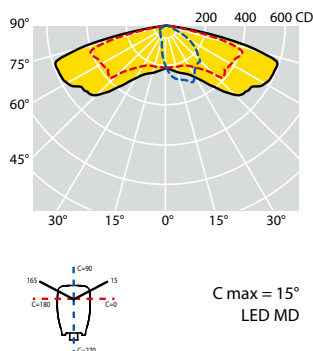

OTTICA S:

Ottica stradale normalmente impiegata per categorie illuminotecniche fino a M3. Tale ottica è particolarmente indicata in situazioni in cui il rapporto tra l'altezza di installazione e la larghezza della carreggiata è inferiore a 1. Risolve strade con interdistanze molto elevate e rapporto interdistanza / altezza d'installazione superiore a 5.

SOPTIC:

Street optic normally used for lighting categories up to M3. This optic is particularly suitable for situations where the installation height and the width of the carriageway ratio is less than 1. It is also appropriate for roads with very high interdistances and an interdistance / installation height ratio greater than 5.

Codici prodotto / *Product codes*

4000K - CRI > 70

Codice Code CL I	Codice Code CL II	Numero LED Number of LED	Ottica Optic	Corrente di pilotaggio Led Current (mA)	W (LED+ DRIVER)	Flusso lum. nom. piastra LED Nominal flux LED plate (Lumen)	Flusso utile in uscita Useful output flux (Lumen)	Temp. ambiente Ambient temp.		Peso lordo Gross weight (kg)	Vol. (m ³)
								ta 35°C	ta 55°C		
45628	45619	36 LED	S	200mA	43	8550	6730	•	•	10,00	0,0514
45630	45605	36 LED	S	230mA	49	9650	7590	•	•	10,00	0,0514
45635	45607	36 LED	S	280mA	60	11450	9020	•	•	10,00	0,0514
45637	45595	36 LED	S	350mA	75	13850	10910	•	•	10,00	0,0514
45639	45612	36 LED	S	480mA	103	17450	13820	•	•	10,00	0,0514
45644	45613	48 LED	S	200mA	56	10900	8670	•	•	10,00	0,0514
45646	45598	48 LED	S	350mA	100	18450	14280	•	•	10,00	0,0514
45652	45651	48 LED	S	400mA	114	20450	15860	•	•	10,00	0,0514

Tecnologia LED MD

MD LED technology

47800	47801	24 LED	S	530mA	40	6800	5350	•	•	10,00	0,0514
47802	47803	24 LED	S	700mA	52	8600	6760	•	•	10,00	0,0514
47804	47805	36 LED	S	530mA	58	9900	7750	•	•	10,10	0,0514
47849	47946	36 LED	S	600mA	67	11000	8640	•	•	10,10	0,0514
47806	47807	36 LED	S	700mA	76	12500	9820	•	•	10,10	0,0514

Tecnologia LED Singlechip (2mmq)

Singlechip LED technology (2mmq)

47850	47947	36 LED	S	700mA	76	12950	9850	•	•	10,10	0,0514
47810	47811	36 LED	S	800mA	88	14900	11680	•	•	10,10	0,0514
47851	47948	36 LED	S	900mA	101	16800	13170	•	•	10,10	0,0514
47812	47813	36 LED	S	1000mA	115	17900	14040	•	•	10,10	0,0514

Tecnologia LED Singlechip (4mmq)

Singlechip LED technology (4mmq)

I valori di flusso indicati devono essere considerati con una tolleranza del +/- 10%.
 I valori di potenza elettrica indicati devono essere considerati con una tolleranza del +/- 7%.
 I flussi luminosi indicati in tabella subiranno modifiche e miglioramenti in funzione della continua evoluzione tecnica dell'efficienza luminosa dei led.

*The flux values are to be considered with a tolerance of +/- 10%.
 The wattages values are to be considered with a tolerance of +/- 7%.
 The flows indicated in the table may be changed and improved according to the constant technical evolution of the light efficiency of the led.*



Curve fotometriche / Photometric data

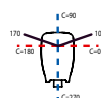
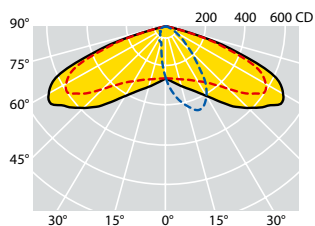

C max = 10°
LED MD

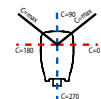
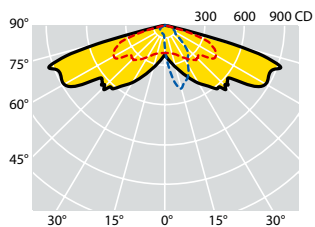
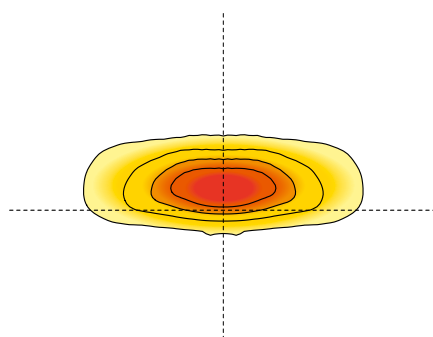

C max = 15°
LED 2mmq

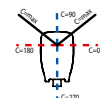
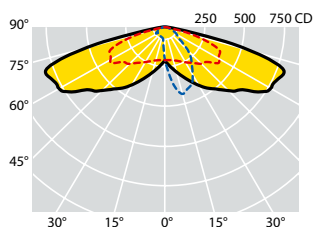
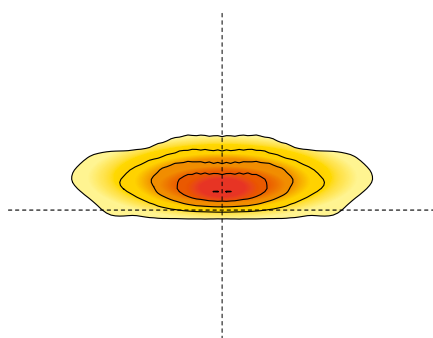

C max = 15°
LED 4mmq

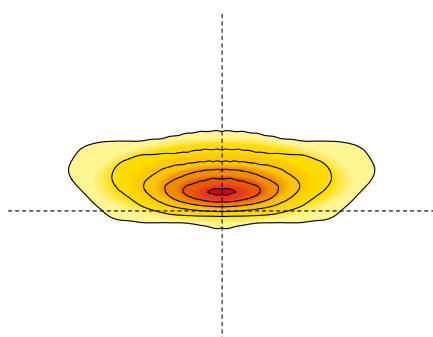

OTTICA V:

Ottica stradale particolarmente indicata in situazioni in cui il rapporto tra l'altezza di installazione e la larghezza della carreggiata è inferiore a 1.

VOPTIC:

Street optic particularly suitable for situations where the installation height and the width of the carriageway ratio is less than 1.

Codici prodotto / *Product codes*

4000K - CRI > 70

Codice Code CL I	Codice Code CL II	Numero LED Number of LED	Ottica Optic	Corrente di pilotaggio Led Current (mA)	W (LED+ DRIVER)	Flusso lum. nom. piastra LED Nominal flux LED plate (Lumen)	Flusso utile in uscita Useful output flux (Lumen)	Temp. ambiente Ambient temp. ta 35°C ta 55°C		Peso lordo Gross weight (kg)	Vol. (m ³)
45629	45604	36 LED	V	200mA	43	8550	7140	•	•	10,00	0,0514
45631	45606	36 LED	V	230mA	49	9650	8050	•	•	10,00	0,0514
45636	45611	36 LED	V	280mA	60	11450	9580	•	•	10,00	0,0514
45638	45596	36 LED	V	350mA	75	13850	11570	•	•	10,00	0,0514
45643	45597	36 LED	V	480mA	103	17450	14580	•	•	10,00	0,0514
45645	45614	48 LED	V	200mA	56	10900	9120	•	•	10,00	0,0514
45647	45599	48 LED	V	350mA	100	18450	15400	•	•	10,00	0,0514
45654	45653	48 LED	V	400mA	114	20450	17080	•	•	10,00	0,0514

Tecnologia LED MD

MD LED technology

47820	47821	24 LED	V	530mA	40	6800	5700	•	•	10,00	0,0514
47822	47823	24 LED	V	700mA	52	8600	7200	•	•	10,00	0,0514
47824	47825	36 LED	V	530mA	58	9900	8250	•	•	10,10	0,0514
47846	68400	36 LED	V	600mA	67	11000	9200	•	•	10,10	0,0514
47826	47827	36 LED	V	700mA	76	12500	10450	•	•	10,10	0,0514

Tecnologia LED Singlechip (2mmq)

Singlechip LED technology (2mmq)

47847	68401	36 LED	V	700mA	76	12950	10810	•	•	10,10	0,0514
47830	47831	36 LED	V	800mA	88	14900	12440	•	•	10,10	0,0514
47848	68402	36 LED	V	900mA	101	16800	14020	•	•	10,10	0,0514
47832	47833	36 LED	V	1000mA	115	17900	14940	•	•	10,10	0,0514

Tecnologia LED Singlechip (4mmq)

Singlechip LED technology (4mmq)

I valori di flusso indicati devono essere considerati con una tolleranza del +/- 10%.
I valori di potenza elettrica indicati devono essere considerati con una tolleranza del +/- 7%.
I flussi luminosi indicati in tabella subiranno modifiche e miglioramenti in funzione della continua evoluzione tecnica dell'efficienza luminosa dei led.

*The flux values are to be considered with a tolerance of +/- 10%.
The wattages values are to be considered with a tolerance of +/- 7%.
The flows indicated in the table may be changed and improved according to the constant technical evolution of the light efficiency of the led.*



Curve fotometriche / Photometric data

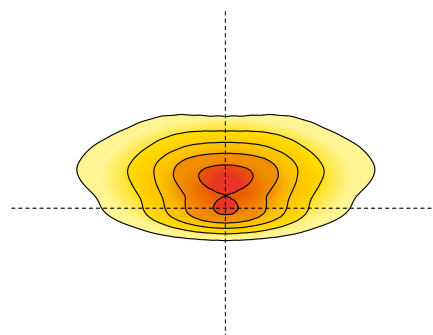
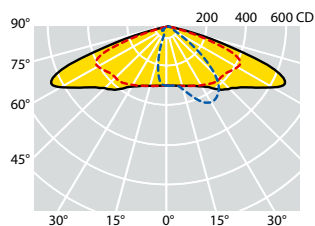

C max = 15°
LED MD

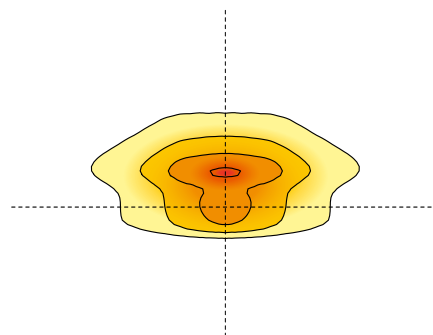
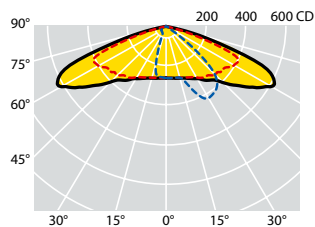

C max = 20°
LED 2mmq

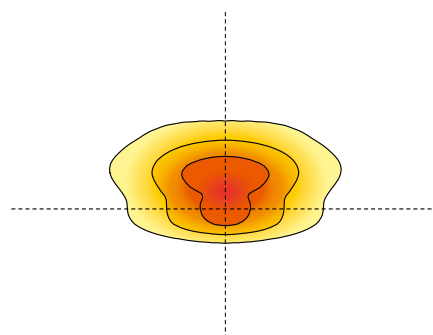
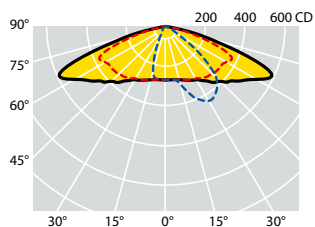

C max = 15°
LED 4x4mmq

OTTICA AB1:

Ottica stradale normalmente impiegata per tutte le categorie illuminotecniche, specialmente quando il rapporto tra l'altezza di installazione dell'apparecchio e la larghezza della carreggiata è maggiore di 0,85. Risolve strade con rapporto tra l'interdistanza dei pali e l'altezza di installazione anche superiore a 4.

AB1 OPTIC:

Street optic normally used for all street illumination categories, especially when the relation between the installation height and the carriage width is greater than 0.85. This optic solves roads with a relationship between the poles distance and the installation height even higher than 4.

Codici prodotto / *Product codes*

4000K - CRI > 70

Codice Code CL I	Codice Code CL II	Numero LED Number of LED	Ottica Optic	Corrente di pilotaggio Led Current (mA)	W (LED+ DRIVER)	Flusso lum. nom. piastra LED Nominal flux LED plate (Lumen)	Flusso utile in uscita Useful output flux (Lumen)	Temp. ambiente Ambient temp. ta 35°C ta 55°C		Peso lordo Gross weight (kg)	Vol. (m ³)
62315	62242	10 LED	AB1	200mA	12	2250	1910	•	•	6,80	0,0293
62316	62243	10 LED	AB1	280mA	17	3150	2650	•	•	6,80	0,0293
62223	62176	10 LED	AB1	350mA	22	3850	3240	•	•	6,80	0,0293
62317	62244	15 LED	AB1	260mA	24	4250	3570	•	•	6,80	0,0293
62224	62177	15 LED	AB1	320mA	30	5150	4320	•	•	6,80	0,0293
62225	62191	20 LED	AB1	280mA	34	6200	5190	•	•	6,80	0,0293
62226	62178	20 LED	AB1	350mA	43	7600	6370	•	•	6,80	0,0293
62206	62205	20 LED	AB1	410mA	51	8700	7290	•	•	6,80	0,0293
62227	62192	25 LED	AB1	350mA	56	9700	8100	•	•	6,80	0,0293
62228	62179	25 LED	AB1	400mA	62	10700	8920	•	•	6,80	0,0293
62229	62193	25 LED	AB1	450mA	69	11800	9840	•	•	6,80	0,0293

Tecnologia LED MD

MDLED technology

62112	62113	10 LED	AB1	350mA	11	1850	1560	•	•	6,80	0,0293
62000	62001	10 LED	AB1	530mA	17	2800	2370	•	•	6,80	0,0293
62400	62483	15 LED	AB1	500mA	24	3800	3190	•	•	6,80	0,0293
62008	62009	20 LED	AB1	530mA	33	5350	4480	•	•	6,80	0,0293
62401	62484	25 LED	AB1	500mA	39	6200	5180	•	•	6,80	0,0293

Tecnologia LED Singlechip (2mmq)

Singlechip LED technology (2mmq)

62403	62485	6 LED	AB1	500mA	37	6600	5500	•	•	6,80	0,0293
62404	62486	6 LED	AB1	600mA	45	7750	6470	•	•	6,80	0,0293
62124	62125	6 LED	AB1	700mA	52	8550	7140	•	•	6,80	0,0293
62024	62025	6 LED	AB1	800mA	58	9300	7750	•	•	6,80	0,0293
62405	62487	6 LED	AB1	900mA	65	10300	8610	•	•	6,80	0,0293
62406	62488	9 LED	AB1	600mA	64	10600	8870	•	•	6,80	0,0293
62120	62121	9 LED	AB1	700mA	75	12100	10090	•	•	6,80	0,0293

Tecnologia LED Multichip (4X4mmq)

Multichip LED technology (4X4mmq)

I valori di flusso indicati devono essere considerati con una tolleranza del +/- 10%.
I valori di potenza elettrica indicati devono essere considerati con una tolleranza del +/- 7%.
I flussi luminosi indicati in tabella subiranno modifiche e miglioramenti in funzione della continua evoluzione tecnica dell'efficienza luminosa dei led.

*The flux values are to be considered with a tolerance of +/- 10%.
The wattages values are to be considered with a tolerance of +/- 7%.
The flows indicated in the table may be changed and improved according to the constant technical evolution of the light efficiency of the led.*



Curve fotometriche / Photometric data

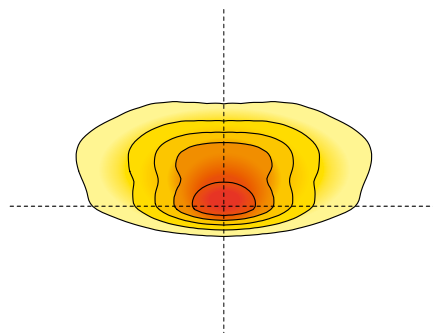
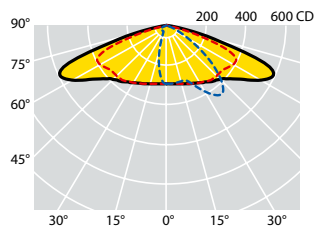

C max = 20°
LED MD

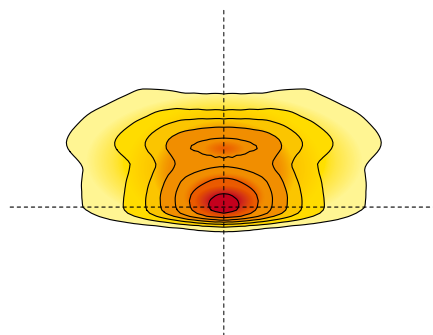
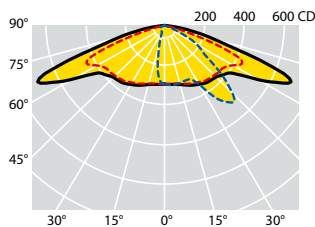

C max = 30°
LED 2mmq

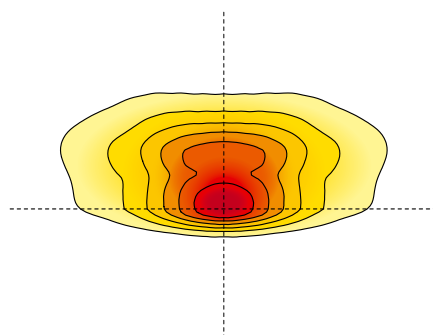
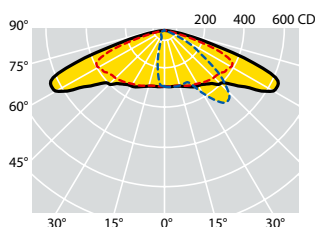

C max = 25°
LED 4x4mmq

OTTICA L10:

Ottica stradale normalmente impiegata per tutte le categorie illuminotecniche, specialmente quando il rapporto tra l'altezza di installazione dell'apparecchio e la larghezza della carreggiata è notevolmente maggiore di 1. Grazie al sistema ottico brevettato Safeway, che sfrutta la possibilità di inclinare i riflettori con angoli diversi, tale ottica permette di illuminare aree frontali molto ampie, risolvendo larghe carreggiate, strade a più corsie, parcheggi e piazzali molto profondi.

L10 OPTIC:

Street optic normally used for all categories lighting, especially when the installation height and the carriage width ratio is considerably greater than 1. Thanks to the Safeway patented optical system, which uses the possibility of tilting the reflectors with different inclinations, with this optic is possible to light wide frontal areas, resolving broad carriageways, roads with multiple lanes, parking spaces and very deep squares.

Codici prodotto / *Product codes*

4000K - CRI > 70

Codice Code CL I	Codice Code CL II	Numero LED Number of LED	Ottica Optic	Corrente di pilotaggio Led Current (mA)	W (LED+ DRIVER)	Flusso lum. nom. piastra LED Nominal flux LED plate (Lumen)	Flusso utile in uscita Useful output flux (Lumen)	Temp. ambiente Ambient temp. ta 35°C ta 55°C		Peso lordo Gross weight (kg)	Vol. (m ³)
62337	62264	10 LED	L10	200mA	12	2250	1870	•	•	6,80	0,0293
62338	62265	10 LED	L10	280mA	17	3150	2600	•	•	6,80	0,0293
62329	62256	10 LED	L10	350mA	22	3850	3180	•	•	6,80	0,0293
62339	62266	15 LED	L10	260mA	24	4250	3490	•	•	6,80	0,0293
62330	62257	15 LED	L10	320mA	30	5150	4240	•	•	6,80	0,0293
62331	62258	20 LED	L10	280mA	34	6200	5080	•	•	6,80	0,0293
62332	62259	20 LED	L10	350mA	43	7600	6350	•	•	6,80	0,0293
62333	62260	20 LED	L10	410mA	51	8700	7150	•	•	6,80	0,0293
62334	62261	25 LED	L10	350mA	56	9700	7940	•	•	6,80	0,0293
62335	62262	25 LED	L10	400mA	62	10700	8750	•	•	6,80	0,0293
62336	62263	25 LED	L10	450mA	69	11800	9640	•	•	6,80	0,0293

Tecnologia LED MD

MDLED technology

62425	62507	10 LED	L10	350mA	11	1850	1530	•	•	6,80	0,0293
62426	62508	10 LED	L10	530mA	17	2800	2320	•	•	6,80	0,0293
62427	62509	15 LED	L10	500mA	24	3800	3130	•	•	6,80	0,0293
62428	62510	20 LED	L10	530mA	33	5350	4390	•	•	6,80	0,0293
62429	62511	25 LED	L10	500mA	39	6200	5075	•	•	6,80	0,0293

Tecnologia LED Singlechip (2mmq)

Singlechip LED technology (2mmq)

62430	62512	6 LED	L10	500mA	37	6600	5390	•	•	6,80	0,0293
62431	62513	6 LED	L10	600mA	45	7750	6340	•	•	6,80	0,0293
62432	62514	6 LED	L10	700mA	52	8550	6990	•	•	6,80	0,0293
62433	62515	6 LED	L10	800mA	58	9300	7590	•	•	6,80	0,0293
62434	62516	6 LED	L10	900mA	65	10300	8440	•	•	6,80	0,0293
62435	62517	9 LED	L10	600mA	64	10600	8690	•	•	6,80	0,0293
62436	62518	9 LED	L10	700mA	75	12100	9890	•	•	6,80	0,0293

Tecnologia LED Multichip (4X4mmq)

Multichip LED technology (4X4mmq)

I valori di flusso indicati devono essere considerati con una tolleranza del +/- 10%.
I valori di potenza elettrica indicati devono essere considerati con una tolleranza del +/- 7%.

I flussi luminosi indicati in tabella subiranno modifiche e miglioramenti in funzione della continua evoluzione tecnica dell'efficienza luminosa dei led.

The flux values are to be considered with a tolerance of +/- 10%.

The wattages values are to be considered with a tolerance of +/- 7%.

The flows indicated in the table may be changed and improved according to the constant technical evolution of the light efficiency of the led.



Curve fotometriche / Photometric data

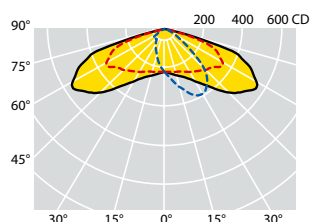

C max = 15°
LED MD

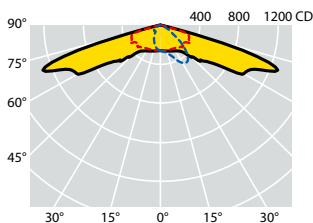
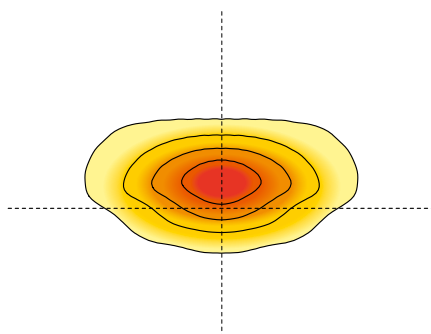

C max = 25°
LED 2mmq

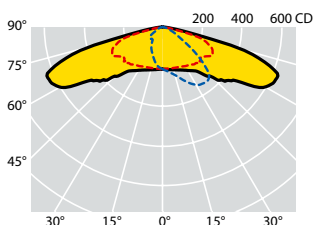
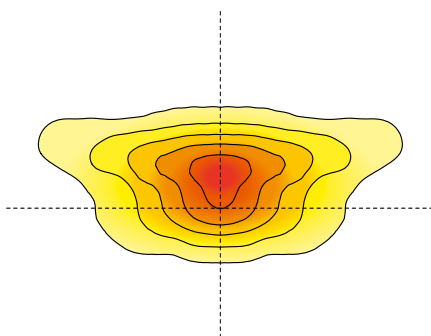

C max = 20°
LED 4mmq

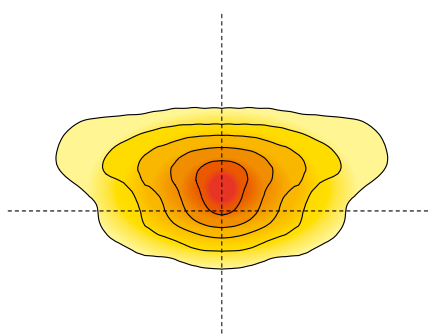

OTTICA W2:

Ottica stradale normalmente impiegata per tutte le categorie illuminotecniche, specialmente quando il rapporto tra l'altezza di installazione dell'apparecchio e la larghezza della carreggiata è maggiore di 0,85. L'ottica W2, presenta un notevole retroflusso che permette di risolvere installazioni con sbracci.

W2 OPTIC:

Street optic normally used for all categories lighting, especially when the installation height and the carriage width ratio is considerably greater than 0.85. The W2 optic features a notable back-flow that allows to solve installations with outreaches.

Codici prodotto / *Product codes*

4000K - CRI > 70

Codice Code CL I	Codice Code CL II	Numero LED Number of LED	Ottica Optic	Corrente di pilotaggio Led Current (mA)	W (LED+ DRIVER)	Flusso lum. nom. piastra LED Nominal flux LED plate (Lumen)	Flusso utile in uscita Useful output flux (Lumen)	Temp. ambiente Ambient temp. ta 35°C ta 55°C		Peso lordo Gross weight (kg)	Vol. (m ³)
62377	62304	8 LED	W2	200mA	10	1950	1630	•	•	6,80	0,0293
62378	62305	8 LED	W2	300mA	15	2800	2370	•	•	6,80	0,0293
62370	62297	16 LED	W2	200mA	20	3900	3260	•	•	6,80	0,0293
62375	62302	16 LED	W2	250mA	25	4650	3910	•	•	6,80	0,0293
62376	62303	16 LED	W2	300mA	30	5550	4640	•	•	6,80	0,0293
62371	62298	16 LED	W2	350mA	35	6400	5350	•	•	6,80	0,0293
62372	62299	24 LED	W2	280mA	44	8200	6850	•	•	6,80	0,0293
62373	62300	24 LED	W2	400mA	59	10550	8830	•	•	6,80	0,0293
62374	62301	24 LED	W2	455mA	67	11950	9960	•	•	6,80	0,0293

Tecnologia LED MD

MD LED technology

62461	62543	8 LED	W2	530mA	13	2200	1870	•	•	6,80	0,0293
62462	62544	8 LED	W2	700mA	18	2900	2420	•	•	6,80	0,0293
62463	62545	16 LED	W2	530mA	26	4500	3770	•	•	6,80	0,0293
62464	62546	16 LED	W2	700mA	35	5750	4820	•	•	6,80	0,0293
62465	62547	24 LED	W2	530mA	40	6800	5690	•	•	6,80	0,0293
62466	62548	24 LED	W2	700mA	52	8500	7120	•	•	6,80	0,0293

Tecnologia LED Singlechip (2mmq)

Singlechip LED technology (2mmq)

62467	62549	16 LED	W2	750mA	37	6200	5200	•	•	6,80	0,0293
62468	62550	16 LED	W2	800mA	40	6600	5500	•	•	6,80	0,0293
62469	62551	16 LED	W2	900mA	45	7300	6120	•	•	6,80	0,0293
62470	62552	24 LED	W2	700mA	52	8700	7290	•	•	6,80	0,0293
62471	62553	24 LED	W2	800mA	59	9850	8210	•	•	6,80	0,0293

Tecnologia LED Singlechip (4mmq)

Singlechip LED technology (4mmq)

I valori di flusso indicati devono essere considerati con una tolleranza del +/- 10%.
I valori di potenza elettrica indicati devono essere considerati con una tolleranza del +/- 7%.
I flussi luminosi indicati in tabella subiranno modifiche e miglioramenti in funzione della continua evoluzione tecnica dell'efficienza luminosa dei led.

*The flux values are to be considered with a tolerance of +/- 10%.
The wattages values are to be considered with a tolerance of +/- 7%.
The flows indicated in the table may be changed and improved according to the constant technical evolution of the light efficiency of the led.*



Curve fotometriche / Photometric data

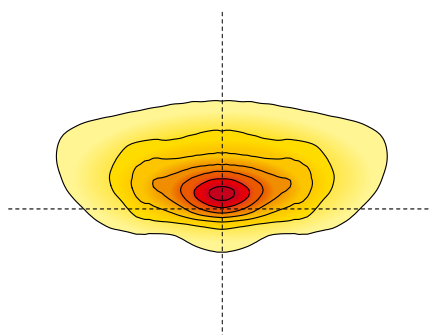
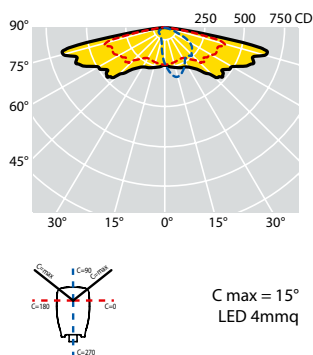
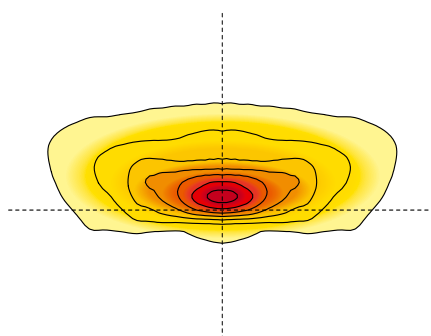
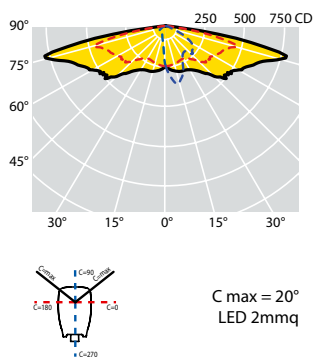
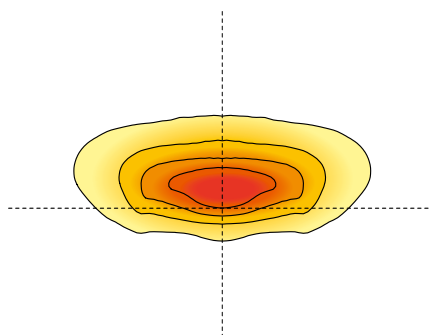
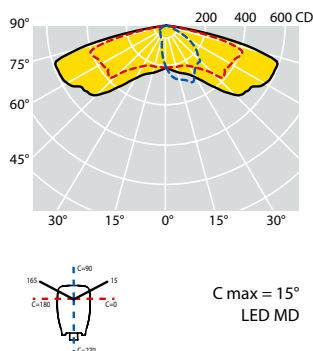

OTTICA S:

Ottica stradale normalmente impiegata per categorie illuminotecniche fino a M3. Tale ottica è particolarmente indicata in situazioni in cui il rapporto tra l'altezza di installazione e la larghezza della carreggiata è inferiore a 1. Risolve strade con interdistanze molto elevate e rapporto interdistanza / altezza d'installazione superiore a 5.

SOPTIC:

Street optic normally used for lighting categories up to M3. This optic is particularly suitable for situations where the installation height and the width of the carriageway ratio is less than 1. It is also appropriate for roads with very high interdistances and an interdistance / installation height ratio greater than 5.

Codici prodotto / *Product codes*

4000K - CRI > 70

Codice Code CL I	Codice Code CL II	Numero LED Number of LED	Ottica Optic	Corrente di pilotaggio Led Current (mA)	W (LED+ DRIVER)	Flusso lum. nom. piastra LED Nominal flux LED plate (Lumen)	Flusso utile in uscita Useful output flux (Lumen)	Temp. ambiente Ambient temp. ta 35°C ta 55°C		Peso lordo Gross weight (kg)	Vol. (m ³)
62368	62295	8 LED	S	200mA	10	1950	1530	•	•	6,80	0,0293
62369	62296	8 LED	S	300mA	15	2800	2230	•	•	6,80	0,0293
62230	62194	16 LED	S	200mA	20	3900	3060	•	•	6,80	0,0293
62366	62293	16 LED	S	250mA	25	4650	3670	•	•	6,80	0,0293
62367	62294	16 LED	S	300mA	30	5550	4350	•	•	6,80	0,0293
62232	62195	16 LED	S	350mA	35	6400	5100	•	•	6,80	0,0293
62234	62196	24 LED	S	280mA	44	8200	6420	•	•	6,80	0,0293
62236	62198	24 LED	S	400mA	59	10550	8210	•	•	6,80	0,0293
62238	62199	24 LED	S	455mA	67	11950	9230	•	•	6,80	0,0293

Tecnologia LED MD

MDLED technology

62080	62081	8 LED	S	530mA	13	2200	1750	•	•	6,80	0,0293
62082	62083	8 LED	S	700mA	18	2900	2270	•	•	6,80	0,0293
62084	62085	16 LED	S	530mA	26	4500	3540	•	•	6,80	0,0293
62086	62087	16 LED	S	700mA	35	5750	4530	•	•	6,80	0,0293
62088	62089	24 LED	S	530mA	40	6800	5340	•	•	6,80	0,0293
62090	62091	24 LED	S	700mA	52	8500	6690	•	•	6,80	0,0293

Tecnologia LED Singlechip (2mmq)

Singlechip LED technology (2mmq)

62457	62539	16 LED	S	750mA	37,5	6200	4880	•	•	6,80	0,0293
62218	62219	16 LED	S	800mA	40	6600	5170	•	•	6,80	0,0293
62458	62540	16 LED	S	900mA	45	7300	5750	•	•	6,80	0,0293
62459	62541	24 LED	S	700mA	52	8700	6850	•	•	6,80	0,0293
62092	62093	24 LED	S	800mA	59	9850	7710	•	•	6,80	0,0293

Tecnologia LED Singlechip (4mmq)

Singlechip LED technology (4mmq)

I valori di flusso indicati devono essere considerati con una tolleranza del +/- 10%.
I valori di potenza elettrica indicati devono essere considerati con una tolleranza del +/- 7%.
I flussi luminosi indicati in tabella subiranno modifiche e miglioramenti in funzione della continua evoluzione tecnica dell'efficienza luminosa dei led.

*The flux values are to be considered with a tolerance of +/- 10%.
The wattages values are to be considered with a tolerance of +/- 7%.
The flows indicated in the table may be changed and improved according to the constant technical evolution of the light efficiency of the led.*



Curve fotometriche / Photometric data

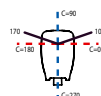
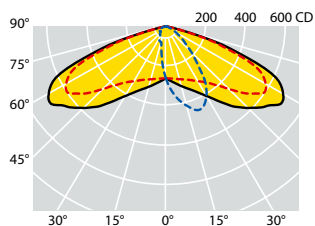

C max = 10°
LED MD

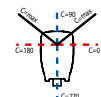
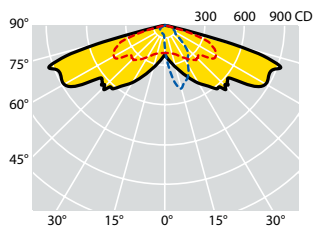
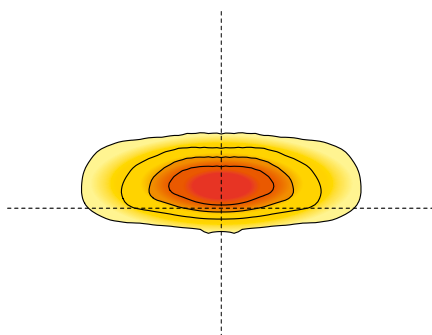

C max = 15°
LED 2mmq

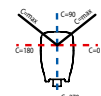
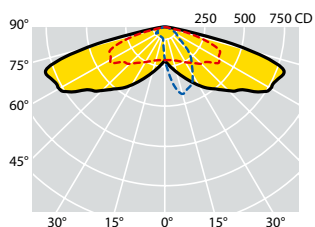
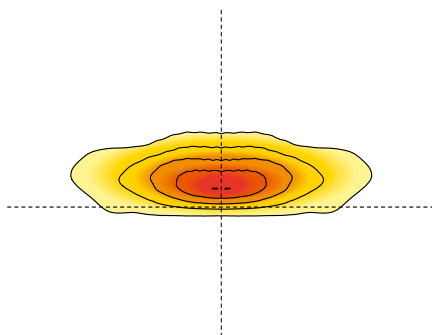

C max = 15°
LED 4mmq

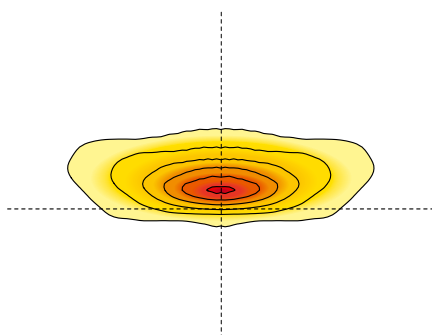

OTTICA V:

Ottica stradale particolarmente indicata in situazioni in cui il rapporto tra l'altezza di installazione e la larghezza della carreggiata è inferiore a 1.

VOPTIC:

Street optic particularly suitable for situations where the installation height and the width of the carriageway ratio is less than 1.

Codici prodotto / *Product codes*

4000K - CRI > 70

Codice Code CL I	Codice Code CL II	Numero LED Number of LED	Ottica Optic	Corrente di pilotaggio Led Current (mA)	W (LED+ DRIVER)	Flusso lum. nom. piastra LED Nominal flux LED plate (Lumen)	Flusso utile in uscita Useful output flux (Lumen)	Temp. ambiente Ambient temp. ta 35°C ta 55°C		Peso lordo Gross weight (kg)	Vol. (m ³)
62364	62291	8 LED	V	200mA	10	1950	1630	•	•	6,80	0,0293
62365	62292	8 LED	V	300mA	15	2800	2370	•	•	6,80	0,0293
62231	62180	16 LED	V	200mA	20	3900	3260	•	•	6,80	0,0293
62362	62289	16 LED	V	250mA	25	4650	3910	•	•	6,80	0,0293
62363	62290	16 LED	V	300mA	30	5550	4640	•	•	6,80	0,0293
62233	62181	16 LED	V	350mA	35	6400	5350	•	•	6,80	0,0293
62235	62197	24 LED	V	280mA	44	8200	6850	•	•	6,80	0,0293
62237	62182	24 LED	V	400mA	59	10550	8830	•	•	6,80	0,0293
62239	62183	24 LED	V	455mA	67	11950	9960	•	•	6,80	0,0293

Tecnologia LED MD

MD LED technology

62096	62097	8 LED	V	530mA	13	2200	1870	•	•	6,80	0,0293
62098	62099	8 LED	V	700mA	18	2900	2420	•	•	6,80	0,0293
62100	62101	16 LED	V	530mA	26	4500	3770	•	•	6,80	0,0293
62102	62103	16 LED	V	700mA	35	5750	4820	•	•	6,80	0,0293
62104	62105	24 LED	V	530mA	40	6800	5690	•	•	6,80	0,0293
62106	62107	24 LED	V	700mA	52	8500	7120	•	•	6,80	0,0293

Tecnologia LED Singlechip (2mmq)

Singlechip LED technology (2mmq)

62451	62533	16 LED	V	750mA	37,5	6200	5200	•	•	6,80	0,0293
62220	62221	16 LED	V	800mA	40	6600	5500	•	•	6,80	0,0293
62452	62534	16 LED	V	900mA	45	7300	6120	•	•	6,80	0,0293
62453	62535	24 LED	V	700mA	52	8700	7290	•	•	6,80	0,0293
62108	62109	24 LED	V	800mA	59	9850	8210	•	•	6,80	0,0293

Tecnologia LED Singlechip (4mmq)

Singlechip LED technology (4mmq)

I valori di flusso indicati devono essere considerati con una tolleranza del +/- 10%.
I valori di potenza elettrica indicati devono essere considerati con una tolleranza del +/- 7%.
I flussi luminosi indicati in tabella subiranno modifiche e miglioramenti in funzione della continua evoluzione tecnica dell'efficienza luminosa dei led.

*The flux values are to be considered with a tolerance of +/- 10%.
The wattages values are to be considered with a tolerance of +/- 7%.
The flows indicated in the table may be changed and improved according to the constant technical evolution of the light efficiency of the led.*

Accessori e ricambi / Accessories and spare parts



60031
Mensola a spigolo componibile
Modular corner bracket



60026
Mensola a parete elettrosaldata
Wall bracket electro welded



60030
Mensola a parete componibile
Modular wall bracket



60063
Mensola a spigolo elettrosaldata
Corner bracket electro welded

Codice Code	Descrizione Description	Peso Lordo Gross Weight (Kg)	Conf. Packing (Pz./Pcs)	Colore Color	Vol. (m ³)
60026	Mensola a parete elettrosaldata Ø mm 60 Wall bracket electro welded Ø mm 60	1,27	6	Zincata a caldo Hot galvanized	0,00257
60030	Mensola a parete componibile Ø mm 60 Modular wall bracket Ø mm 60	1,05	4	Zincata a caldo Hot galvanized	0,00160
60063	Mensola a spigolo elettrosaldata Ø mm 60 Corner bracket electro welded Ø mm 60	2,60	4	Zincata a caldo Hot galvanized	0,00835
60031	Mensola a spigolo componibile Ø mm 60 Modular corner bracket Ø mm 60	1,90	3	Zincata a caldo Hot galvanized	0,00210
18332	CHALLENGE Vetro temperato extra chiaro 4 mm Extra-clear tempered glass 4 mm thick				
20643	CHALLENGE CITY Vetro temperato extra chiaro 4 mm Extra-clear tempered glass 4 mm thick				
25786	CHALLENGE WAY Vetro temperato extra chiaro 4 mm Extra-clear tempered glass 4 mm thick				

CHALLENGE SERIES

Esercizi illuminotecnici / *Lighting exercises*EN
13201-2

Categorie illuminotecniche stradali secondo la norma tecnica EN 13201-2
Street lighting categories, in accordance with the technical regulation EN 13201-2.

CHALLENGE - 80 LED SINGLECHIP - OTTICA V - 800mA
CHALLENGE - 80 LED SINGLECHIP - V OPTIC - 800mA

Dati		Data						
Larghezza carreggiata:	2X14 metri	Carriageway width:	2X14 meters					
Numero di corsie:	2X4	Number of lanes:	2X4					
Altezza di installazione:	14 metri	Installation height:	14 meters					
Interdistanza pali:	50 metri	Poles distance:	50 meters					
Posizionamento pali:	doppia fila affiancata	Poles positioning:	double row opposing					
Fattore di manutenzione:	0,80	Maintenance factor:	0.80					
Lav	U0	UI	fTI	EIR*	P (W)	Efficiency (lm/W)	IPEI	CATEGORY
1,53	0,50	0,80	10%	0,46	198	139	0,32	M2

CHALLENGE CITY - 48 LED MD - OTTICA W2 - 350mA
CHALLENGE CITY - 48 LED MD - W2 OPTIC - 350mA

Dati		Data						
Larghezza carreggiata:	2X10,5 metri	Carriageway width:	2X10,5 meters					
Numero di corsie:	2X3	Number of lanes:	2X3					
Altezza di installazione:	9 metri	Installation height:	9 meters					
Interdistanza pali:	30 metri	Poles distance:	30 meters					
Posizionamento pali:	doppia fila affiancata	Poles positioning:	double row opposing					
Fattore di manutenzione:	0,80	Maintenance factor:	0.80					
Lav	U0	UI	fTI	EIR*	P (W)	Efficiency (lm/W)	IPEI	CATEGORY
1,51	0,45	0,74	9%	0,61	100	151	0,33	M2

CHALLENGE WAY - 24 LED MD - OTTICA S - 400mA
CHALLENGE WAY - 24 LED MD - S OPTIC - 400mA

Dati		Data						
Larghezza carreggiata:	8 metri	Carriageway width:	8 meters					
Numero di corsie:	2	Number of lanes:	2					
Altezza di installazione:	8,50 metri	Installation height:	8.5 meters					
Interdistanza pali:	40 metri	Poles distance:	40 meters					
Posizionamento pali:	unilaterale	Poles positioning:	unilateral					
Fattore di manutenzione:	0,80	Maintenance factor:	0.80					
Lav	U0	UI	fTI	EIR*	P (W)	Efficiency (lm/W)	IPEI	CATEGORY
0,77	0,40	0,62	14%	0,48	59	136,44	0,39	M4

* EIR Edge Illumination Ratio secondo la norma EN 13201-2: 2015
 * EIR Edge Illumination Ratio in accordance with EN 13201-2: 2015